

ONKYO®

AV Receiver

TX-SR700/700E *TX-SR600/600E*

Instruction Manual

Thank you for purchasing the Onkyo AV Receiver. Please read this manual thoroughly before making connections and plugging in the unit. Following the instructions in this manual will enable you to obtain optimum performance and listening enjoyment from your new AV Receiver. Please retain this manual for future reference.

Contents

Before using	2
---------------------	----------

Facilities and connections	8
-----------------------------------	----------

Setup and operation	36
----------------------------	-----------

Remote controller	63
--------------------------	-----------

Appendix	76
-----------------	-----------

WARNING:

TO REDUCE THE RISK OF FIRE OR ELECTRIC SHOCK, DO NOT EXPOSE THIS APPLIANCE TO RAIN OR MOISTURE.

CAUTION:

TO REDUCE THE RISK OF ELECTRIC SHOCK, DO NOT REMOVE COVER (OR BACK). NO USER-SERVICEABLE PARTS INSIDE. REFER SERVICING TO QUALIFIED SERVICE PERSONNEL.



WARNING
RISK OF ELECTRIC SHOCK
DO NOT OPEN

AVIS
RISQUE DE CHOC ELECTRIQUE
NE PAS OUVRIR



The lightning flash with arrowhead symbol, within an equilateral triangle, is intended to alert the user to the presence of uninsulated "dangerous voltage" within the product's enclosure that may be of sufficient magnitude to constitute a risk of electric shock to persons.



The exclamation point within an equilateral triangle is intended to alert the user to the presence of important operating and maintenance (servicing) instructions in the literature accompanying the appliance.

Important Safeguards

1. **Read Instructions** – All the safety and operating instructions should be read before the appliance is operated.
2. **Retain Instructions** – The safety and operating instructions should be retained for future reference.
3. **Heed Warnings** – All warnings on the appliance and in the operating instructions should be adhered to.
4. **Follow Instructions** – All operating and use instructions should be followed.
5. **Cleaning** – Unplug the appliance from the wall outlet before cleaning. The appliance should be cleaned only as recommended by the manufacturer.
6. **Attachments** – Do not use attachments not recommended by the appliance manufacturer as they may cause hazards.
7. **Water and Moisture** – Do not use the appliance near water –for example, near a bath tub, wash bowl, kitchen sink, or laundry tub; in a wet basement; or near a swimming pool; and the like.
8. **Accessories** – Do not place the appliance on an unstable cart, stand, tripod, bracket, or table. The appliance may fall, causing serious injury to a child or adult, and serious damage to the appliance. Use only with a cart, stand, tripod, bracket, or table recommended by the manufacturer, or sold with the appliance. Any mounting of the appliance should follow the manufacturer's instructions, and should use a mounting accessory recommended by the manufacturer.
9. An appliance and cart combination should be moved with care. Quick stops, excessive force, and uneven surfaces may cause the appliance and cart combination to overturn.
10. **Ventilation** – Slots and openings in the cabinet are provided for ventilation and to ensure reliable operation of the appliance and to protect it from overheating, and these openings must not be blocked or covered. The openings should never be blocked by placing the appliance on a bed, sofa, rug, or other similar surface. The appliance should not be placed in a built-in installation such as a bookcase or rack unless proper ventilation is provided. There should be free space of at least 20 cm (8 in.) and an opening behind the appliance.
11. **Power Sources** – The appliance should be operated only from the type of power source indicated on the marking label. If you are not sure of the type of power supply to your home, consult your appliance dealer or local power company.
12. **Grounding or Polarization** – The appliance may be equipped with a polarized alternating current line plug (a plug having one blade wider than the other). This plug will fit into the power outlet only one way. This is a safety feature. If you are unable to insert the plug fully into the outlet, try reversing the plug. If the plug should still fail to fit, contact your electrician to replace your obsolete outlet. Do not defeat the safety purpose of the polarized plug.
13. **Power-Cord Protection** – Power-supply cords should be routed so that they are not likely to be walked on or pinched by items placed upon or against them, paying particular attention to cords at plugs, convenience receptacles, and the point where they exit from the appliance.
14. **Outdoor Antenna Grounding** – If an outside antenna or cable system is connected to the appliance, be sure the antenna or cable system is grounded so as to provide some protection against voltage surges and built-up static charges. Article 810 of the National Electrical Code, ANSI/NFPA 70, provides information with regard to proper grounding of the mast and supporting structure, grounding of the lead-in wire to an antenna-discharge unit, size of grounding conductors, location of antenna-discharge unit, connection to grounding electrodes, and requirements for the grounding electrode. See Figure 1.
15. **Lightning** – For added protection for the appliance during a lightning storm, or when it is left unattended and unused for long periods of time, unplug it from the wall outlet and disconnect the antenna or cable system. This will prevent damage to the appliance due to lightning and power-line surges.
16. **Power Lines** – An outside antenna system should not be located in the vicinity of overhead power lines or other electric light or power circuits, or where it can fall into such power lines or circuits. When installing an outside antenna system, extreme care should be taken to keep from touching such power lines or circuits as contact with them might be fatal.
17. **Overloading** – Do not overload wall outlets, extension cords, or integral convenience receptacles as this can result in a risk of fire or electric shock.
18. **Object and Liquid Entry** – Never push objects of any kind into the appliance through openings as they may touch dangerous voltage points or short-out parts that could result in a fire or electric shock. Never spill liquid of any kind on the appliance.
19. **Servicing** – Do not attempt to service the appliance yourself as opening or removing covers may expose you to dangerous voltage or other hazards. Refer all servicing to qualified service personnel.
20. **Damage Requiring Service** – Unplug the appliance from the wall outlet and refer servicing to qualified service personnel under the following conditions:
 - A. When the power-supply cord or plug is damaged,
 - B. If liquid has been spilled, or objects have fallen into the appliance,
 - C. If the appliance has been exposed to rain or water,
 - D. If the appliance does not operate normally by following the operating instructions. Adjust only those controls that are covered by the operating instructions as an improper adjustment of other controls may result in damage and will often require extensive work by a qualified technician to restore the appliance to its normal operation,
 - E. If the appliance has been dropped or damaged in any way, and
 - F. When the appliance exhibits a distinct change in performance – this indicates a need for service.

PORTABLE CART WARNING



21. **Replacement Parts** – When replacement parts are required, be sure the service technician has used replacement parts specified by the manufacturer or have the same characteristics as the original part. Unauthorized substitutions may result in fire, electric shock, or other hazards.
22. **Safety Check** – Upon completion of any service or repairs to the appliance, ask the service technician to perform safety checks to determine that the appliance is in proper operation condition.
23. **Wall or Ceiling Mounting** – The appliance should be mounted to a wall or ceiling only as recommended by the manufacturer.
24. **Heat** – The appliance should be situated away from heat sources such as radiators, heat registers, stoves, or other appliances (including amplifiers) that produce heat.
25. **Liquid Hazards** – The appliance shall not be exposed to dripping or splashing and no objects filled with liquids, such as vases shall be placed on the appliance.

FIGURE 1:
EXAMPLE OF ANTENNA GROUNDING AS PER NATIONAL
ELECTRICAL CODE, ANSI/NFPA 70

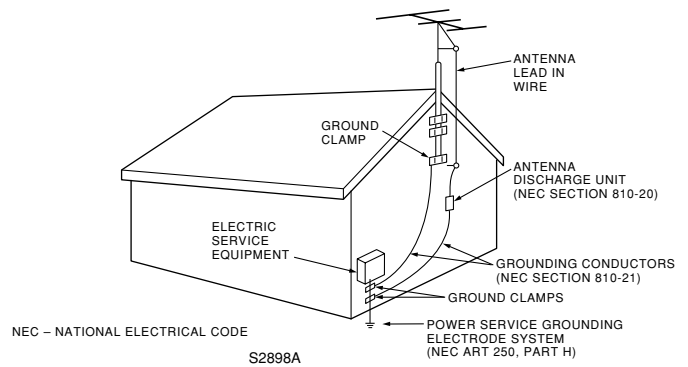

Precautions

1. Recording Copyright

Recording of copyrighted material for other than personal use is illegal without permission of the copyright holder.

2. AC Fuse

The fuse is located inside the chassis and is not user-serviceable. If power does not come on, contact your Onkyo authorized service station.

3. Care

From time to time you should wipe the front and rear panels and the cabinet with a soft cloth. For heavier dirt, dampen a soft cloth in a weak solution of mild detergent and water, wring it out dry, and wipe off the dirt. Following this, dry immediately with a clean cloth. Do not use rough material, thinners, alcohol or other chemical solvents or cloths since these could damage the finish or remove the panel lettering.

4. Power

WARNING

BEFORE PLUGGING IN THE UNIT FOR THE FIRST TIME, READ THE FOLLOWING SECTION CAREFULLY.

The voltage of the available power supply differs according to country or region. Be sure that the power supply voltage of the area where this unit will be used meets the required voltage (e.g., AC 230 V, 50 Hz or AC 120 V, 60 Hz) written on the rear panel.

Worldwide models are equipped with a voltage selector to conform to local power supplies. Be sure to set this switch to match the voltage of the power supply in your area before plugging in the unit.

For British models

Replacement and mounting of an AC plug on the power supply cord of this unit should be performed only by qualified service personnel.

IMPORTANT

The wires in the mains lead are coloured in accordance with the following code:

Blue : Neutral

Brown : Live

As the colours of the wires in the mains lead of this apparatus may not correspond with the coloured markings identifying the terminals in your plug, proceed as follows:

The wire which is coloured blue must be connected to the terminal which is marked with the letter N or coloured black.

The wire which is coloured brown must be connected to the terminal which is marked with the letter L or coloured red.

IMPORTANT

A 5 ampere fuse is fitted in this plug. Should the fuse need to be replaced, please ensure that the replacement fuse has a rating of 5 amperes and that it is approved by ASTA or BSI to BS1362. Check for the ASTA mark or the BSI mark on the body of the fuse.

IF THE FITTED MOULDED PLUG IS UNSUITABLE FOR THE SOCKET OUTLET IN YOUR HOME THEN THE FUSE SHOULD BE REMOVED AND THE PLUG CUT OFF AND DISPOSED OF SAFELY. THERE IS A DANGER OF SEVERE ELECTRICAL SHOCK IF THE CUT OFF PLUG IS INSERTED INTO ANY 13 AMPERE SOCKET.

If in any doubt, consult a qualified electrician.

For U.S. models

Note to CATV system installer:

This reminder is provided to call the CATV system installer's attention to Section 820-40 of the NEC which provides guidelines for proper grounding and, in particular, specifies that the cable ground shall be connected to the grounding system of the building, as close to the point of cable entry as practical.

FCC Information for User

CAUTION:

The user changes or modifications not expressly approved by the party responsible for compliance could void the user's authority to operate the equipment.

NOTE:

This equipment has been tested and found to comply with the limits for a Class B digital device, pursuant to Part 15 of the FCC Rules. These limits are designed to provide reasonable protection against harmful interference in a residential installation. This equipment generates, uses and can radiate radio frequency energy and, if not installed and used in accordance with the instructions, may cause harmful interference to radio communications. However, there is no guarantee that interference will not occur in a particular installation. If this equipment does cause harmful interference to radio or television reception, which can be determined by turning the equipment off and on, the user is encouraged to try to correct the interference by one or more of the following measures:

- Reorient or relocate the receiving antenna.
- Increase the separation between the equipment and receiver.
- Connect the equipment into an outlet on a circuit different from that to which the receiver is connected.
- Consult the dealer or an experienced radio/TV technician for help.

For Canadian models

NOTE: THIS CLASS B DIGITAL APPARATUS COMPLIES WITH CANADIAN ICES-003.

For models having a power cord with a polarized plug:

CAUTION: TO PREVENT ELECTRIC SHOCK, MATCH WIDE BLADE OF PLUG TO WIDE SLOT, FULLY INSERT.

Modèle pour les Canadien

REMARQUE: CET APPAREIL NUMÉRIQUE DE LA CLASSE B EST CON-FORME À LA NORME NMB-003 DU CANADA.

Sur les modèles dont la fiche est polarisée:

ATTENTION: POUR ÉVITER LES CHOCS ÉLECTRIQUES, INTRODUIRE LA LAME LA PLUS LARGE DE LA FICHE DANS LA BORNE CORRESPONDANTE DE LA PRISE ET POUSSER JUSQU'AU FOND.

Contents

Before using

Important Safeguards	2
Precautions	3
Contents	4
Features	6
Supplied accessories	7
Before using this unit	7
Setting the voltage selector (Worldwide models only)	7
Installing the remote controller batteries	7
Using the remote controller	7

Facilities and connections

Front panel facilities	8
Front panel	8
Front panel display	11
Remote controller	12
Connections	14
Connections (TX-SR700/700E)	16
Connecting your audio components	16
Connecting your video components	17
12V TRIGGER ZONE 2 terminal	21
PRE OUT	21
Operating components not reached by the remote controller signals (IR IN) (TX-SR700/ 700E only)	22
If the remote controller signal does not reach the TX- SR700/700E remote sensor	22
Connecting the remote zone (Zone 2) speakers (TX-SR700/700E only)	23
When using the ZONE 2 SPEAKERS terminals	23
When using the ZONE 2 PRE OUT terminals	23
AC OUTLETS	29
RI REMOTE CONTROL	29
Connections (TX-SR600/600E)	24
Connecting your audio components	24
Connecting your video components	25
AC OUTLETS	29
RI REMOTE CONTROL	29

Connecting speakers	30
Standard speaker setup for surround sound	30
Minimum speaker configuration for surround sound playback	30
Speaker placement	30
Using the speaker labels	30
Connecting speakers	31
Connecting the speaker cable	31
Connecting a subwoofer	31
Connecting to the SPEAKERS B terminals (TX-SR600/600E only)	31

Connecting the power	33
Turning on the power	33
Turning on the power from the remote controller	33

Connecting antennas	34
Assembling the AM loop antenna	34
Connecting the AM antenna cable	34
Connecting the included antennas	34
Connecting an FM outdoor antenna	35
Connecting an AM outdoor antenna	35
Directional linkage	35
Connecting the antenna cable to the 75/300 Ω antenna adapter (For all models other than USA & Canadian models and European models)	35

Setup and operation

Configuring the speakers	36
Displaying the Main Menu	36
Speaker Configuration	36
Setting the speaker distance from your normal listening position	38
Calibrating the speaker levels	38
Buttons used for navigating through the menus	39
Listening to Radio Broadcasts	40
Tuning into a radio station	40
Listening to a stereo radio station (FM mode)	40
Presetting a radio station	41
Selecting a preset radio station	41
Erasing a preset radio station	41
Listening to RDS broadcasts (European models only)	42
Listening to RDS broadcasts	42
PTY program types in Europe	42
Displaying Radio Text (RT)	43
Performing a PTY scan	43
Performing a TP scan	43

Contents

Selecting an Audio Component	44
Basic operation (TX-SR700/700E)	44
Basic operation (TX-SR600/600E)	45
Selecting speakers (SPEAKERS A, B) (TX-SR600/600E only)	45
Selecting the type of audio input signal	46
Temporarily changing the speaker output levels	46
To change the display of the input source from TAPE to MD	46
Using the sleep time (remote controller only)	47
Listening with headphones	47
Enjoying DVD multichannel audio playback	47
Switching the display	48
Temporarily turning off the sound	48
Listening Modes	49
Selecting a listening mode	51
Original filter (CinemaFILTER) loading for movies	52
Input Setup	53
OSD Setup and Other Settings	56
OSD Setup	56
Preference	56
Audio Adjust	57
Enjoying music in the remote zone (TX-SR700/700E only)	60
Using the buttons on the TX-SR700/700E	60
Using the remote controller	60
Adjusting the volume for the remote zone	60
Recording a source (TX-SR700/700E)	61
To record the input source signal you are currently watching or listening to	61
To record an input source signal different from that you are currently watching or listening to	61
Recording a source (TX-SR600/600E)	62
To record the input source signal you are currently watching or listening to	62

Remote controller

Using remote controller	63
Overview	63
Calling up a preset radio station	63
Controlling an Onkyo cassette tape deck	63
Controlling an Onkyo CD player	64
Controlling an Onkyo DVD player	65
Controlling an Onkyo MD recorder	66
VCR and TV MODE buttons	66

Entering a pre-programming code	67
Learning a pre-programming code	67
Pre-programming codes	68
Operating your programmed remote controller	69
DVD MODE (DVD Player Mode)	69
VCR MODE (VCR Mode)	69
TV MODE (TV Mode)	69
Programming the commands of remote controllers for other devices into the remote controller	70
Programming procedure	70
Erasing the programmed command from one button	72
Erasing all the commands programmed under a MODE button	72
Using the macro function	73
What is the macro function?	73
Programming the macro	73
Executing the macro	73
Erasing a macro from the MACRO 1 (or 2) button	74
Erasing all commands and macros that have been programmed	74
Macro mode programming memo	75

Appendix

Troubleshooting guide	76
POWER	76
SPEAKERS	76
FM/AM TUNER	76
VIDEO and AUDIO	77
REMOTE CONTROLLER	77
OTHER	77
If one of the messages shown below appears	78
Specifications (TX-SR700/700E)	79
Specifications (TX-SR600/600E)	back cover

Declaration of Conformity

We, ONKYO EUROPE
ELECTRONICS GmbH
INDUSTRIESTRASSE 20
82110 GERMERING,
GERMANY



declare in own responsibility, that the ONKYO product described in this instruction manual is in compliance with the corresponding technical standards such as EN60065, EN55013, EN55020 and EN61000-3-2, -3-3.

GERMERING, GERMANY

I. MORI

ONKYO EUROPE ELECTRONICS GmbH

Features

TX-SR700/700E

Amplifier Features

- 100 W × 2 (Front)/ 100 W (Center)/ 100 W × 2 (Surround)/ 100 W (Surround Back) at 8 ohms, 20 Hz - 20 kHz, 0.08 % THD (FTC rated)
- 130 W × 2 (Front)/ 130 W (Center)/ 130 W × 2 (Surround)/ 130 W (Surround Back) at 6 ohms (DIN)
- 160 W × 2 (Front)/ 160 W (Center)/ 160 W × 2 (Surround)/ 160 W (Surround Back) at 6 ohms (JEITA)
- Wide Range Amplifier Technology (WRAT)
- Powered Zone 2 Capability
- State-of-the-art linear PCM 192 kHz/24-bit DACs for L/R channels
- Optimum gain volume circuitry

Audio/Video Features

- Dolby®* Digital, Dolby Digital EX, Dolby Pro Logic II
- DTS, DTS-ES Extended Surround, DTS Neo:6
- Non-Scaling Configuration
- CinemaFILTER
- “Easy-set” speaker configuration
- Pure Audio Mode
- Crossover Adjustment (80/100/120 Hz)
- Onscreen graphical displays
- Digital Outputs (1 coaxial, 1 optical)
- 2 component video inputs and 1 output
- 3 Assignable digital inputs (1 coaxial, 2 optical)
- 5 S-Video inputs and 3 outputs
- Front panel A/V, S-Video, Optical inputs
- Multi channel input for DVD-Audio
- Rec out selector and Zone 2 selector
- Pre-out terminals for Front L/R, Center, Surround L/R, Surround Back, Subwoofer and Zone 2 L/R
- Color-coded speaker terminals

FM/AM Tuner Features

- 40 FM/AM random presets
- FM auto tuning
- RDS (European models) with PS/RT/PTY/TP

Other Performance Features

- IntelliVolume
- Powerful backlit/preprogrammed learning remote with macro and mode-key LEDs
- 12V Trigger output for Zone 2
- IR input terminal

TX-SR600/600E

Amplifier Features

- 80 W × 2 (Front)/ 80 W (Center)/ 80 W × 2 (Surround)/ 80 W (Surround Back) at 8 ohms, 20 Hz - 20 kHz, 0.08 % THD (FTC rated)
- 115 W × 2 (Front)/ 115 W (Center)/ 115 W × 2 (Surround)/ 115 W (Surround Back) at 6 ohms (DIN)
- 145 W × 2 (Front)/ 145 W (Center)/ 145 W × 2 (Surround)/ 145 W (Surround Back) at 6 ohms (JEITA)
- Wide Range Amplifier Technology (WRAT)
- State-of-the-art linear PCM 192 kHz/24-bit DACs for L/R channels
- Optimum gain volume circuitry

Audio/Video Features

- Dolby Digital, Dolby Digital EX, Dolby Pro Logic II
- DTS, DTS-ES Extended Surround, DTS Neo:6
- Non-Scaling Configuration
- CinemaFILTER
- “Easy-set” speaker configuration
- Crossover Adjustment (80/100/120 Hz)
- Onscreen graphical displays
- Optical Digital Output
- 2 component video inputs and 1 output
- 3 Assignable digital inputs (1 coaxial, 2 optical)
- 5 S-Video inputs and 2 outputs
- Front panel A/V, S-Video, Optical inputs
- Multi channel input for DVD-Audio
- Pre-out terminal for Subwoofer
- Color-coded speaker terminals
- A/B speaker drive

FM/AM Tuner Features

- 40 FM/AM random presets
- FM auto tuning
- RDS (European models) with PS/RT/PTY/TP

Other Performance Features

- IntelliVolume
- Preprogrammed learning remote with macro and mode-key LEDs

* Manufactured under license from Dolby Laboratories.

“Dolby,” “Pro Logic,” and the double-D symbol are trademarks of Dolby Laboratories.

• “DTS,” “DTS-ES Extended Surround,” and “Neo:6” are trademarks of Digital Theater Systems, Inc.

• Xantech is a registered trademark of Xantech Corporation.

• Niles is a registered trademark of Niles Audio Corporation.

Supplied accessories

Check that the following accessories are supplied with the TX-SR700/700E/600/600E.

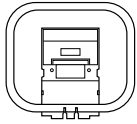

AM loop antenna × 1

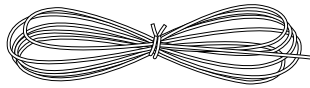

FM indoor antenna × 1

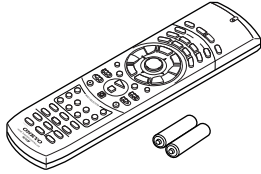

Remote controller × 1
 TX-SR700/700E: RC-482M
 TX-SR600/600E: RC-480M
 Batteries (AA, R6 or UM-3) × 2

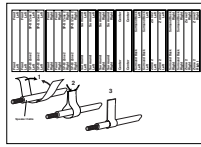

Speaker cable label × 1

The following accessories may be available depending on the area which it was purchased.

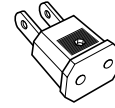

Conversion plug × 1
 (Use this plug if the power cord plug of the TX-SR700/700E/600/600E does not fit your AC outlet. Shape may vary depending on the area which it was purchased.)

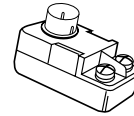

75/300 Ω antenna adapter × 1

Before using this unit

Setting the voltage selector (Worldwide models only)

Worldwide models are equipped with a voltage selector so that you can set your TX-SR700/700E/600/600E to conform with local power supplies. Be sure to set this switch to match the voltage of the power supply in your area before plugging in the unit. Determine the proper voltage for your area: 220-230 V or 120 V. If the preset voltage is not correct for your area, insert a screwdriver into the groove in the switch and slide the switch all the way to the top (120 V) or bottom (220-230 V), whichever is appropriate.

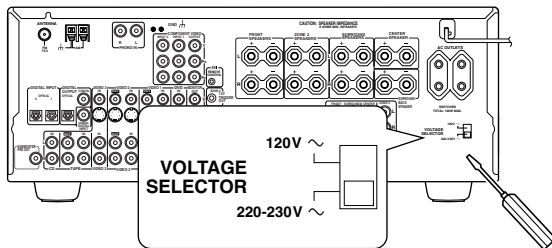

Installing the remote controller batteries

1. Remove the battery compartment cover by pressing it and sliding it in the direction shown by the arrow below.
2. Insert two AA (R6 or UM-3) batteries into the battery compartment. Carefully follow the polarity diagram (positive (+) and negative (-) symbols) inside the battery compartment.
3. After the batteries are installed and seated correctly, replace the compartment cover.

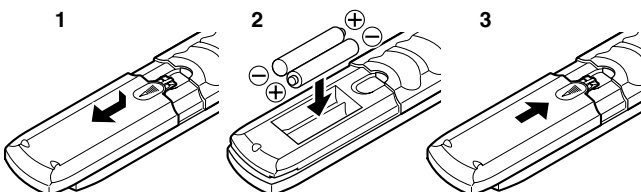

Notes:

- Do not mix new batteries with old batteries or different kinds of batteries.
- To avoid corrosion, remove the batteries if the remote controller will not be used for a long time.
- Remove dead batteries immediately to avoid damage from corrosion. If the remote controller does not operate smoothly, remove the old batteries and replace them both with two new AA batteries.

Using the remote controller

Point the remote controller toward the remote control sensor. The STANDBY indicator lights up when the unit receives a signal from the remote controller.

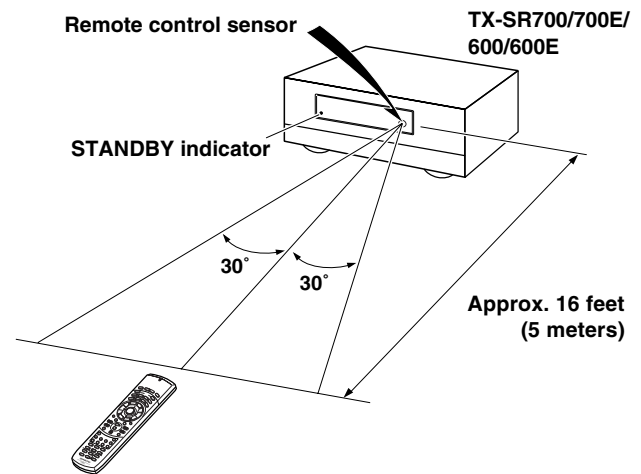

Notes:

- Make sure that the remote control sensor is not subject to strong light such as direct sunlight or inverted fluorescent light for it may prevent proper operation of the remote controller.
- Using another remote controller in the same room or using the TX-SR700/700E/600/600E near equipment that uses infrared rays may cause operational interference.
- Do not put objects on the remote controller. Its buttons may be pressed by mistake and drain the batteries.
- Make sure the audio rack doors do not have colored glass. Placing the TX-SR700/700E/600/600E behind such doors may prevent proper remote controller operation.
- If there is any obstacle between the remote controller and the remote control sensor, the remote controller will not operate.

Front panel facilities

Here is an explanation of the controls and displays on the front panel of the TX-SR700E/600E.

Front panel

<TX-SR700E>

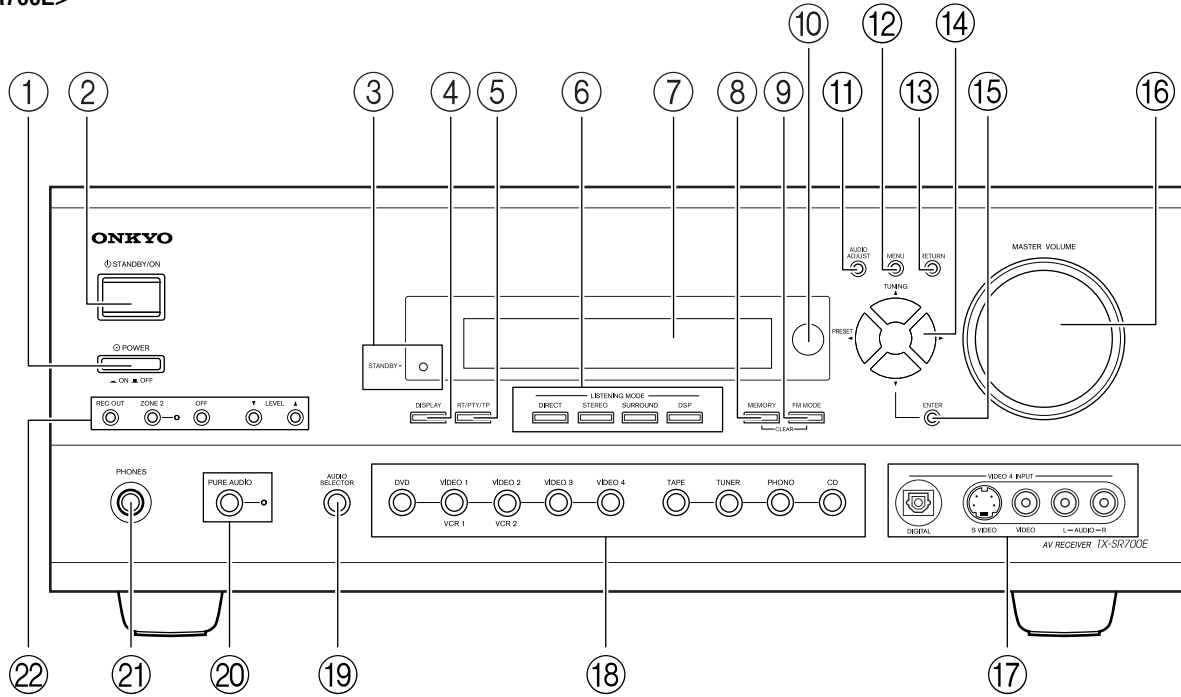

<TX-SR600E>

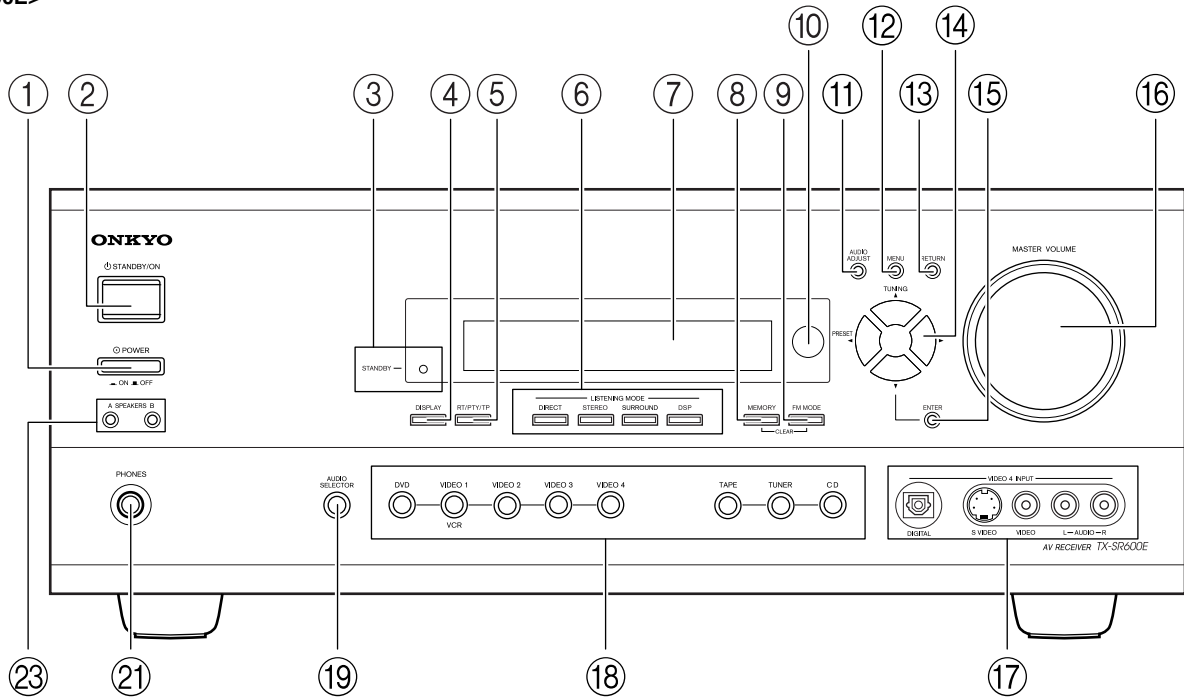

Front panel facilities

For further operational instructions, see the pages indicated in brackets [].

1 POWER switch (for all models other than USA and Canadian models) [33]

Press to turn on and off the main power supply for the TX-SR700/700E/600/600E. When the TX-SR700/700E/600/600E is turned on with the POWER switch, the STANDBY indicator lights.

- Before turning on the power, check to make sure that all cords are properly connected.
- When the power is turned on, a sudden surge of current will occur that may adversely affect the operation of other devices. To prevent this, do not plug the TX-SR700/700E/600/600E into the same circuit used by sensitive equipment, e.g., computers.

2 STANDBY/ON button [33]

If pressed with the POWER switch turned on (with the receiver plugged in for US models), the TX-SR700/700E/600/600E turns on and the display lights up. If pressed again, the TX-SR700/700E/600/600E returns to the standby state. In the standby state, the display is turned off and the TX-SR700/700E/600/600E cannot be operated.

3 STANDBY indicator [7, 33]

Lights when the TX-SR700/700E/600/600E is in the standby state and when a signal is received from the remote controller.

4 DISPLAY button [48]

Press to display information about the current input source signal. Each time you press the display button, the screen changes to show you different information concerning the input signal.

5 RT/PTY/TP (European models only) button [43]

This button is only available on European models. Press this button to tune into the Radio Data System (RDS) for FM broadcasting. RDS was developed within the European Broadcasting Union (EBU) and is available in most European countries. Each time the button is pressed, the display changes from RT (radio text) to PTY (program type) to TP (traffic program) and then back to RT again.

5 DIMMER button

Press to set the brightness of the front display. There are 3 settings available: normal, dark, and very dark.

- The brightness of the front display can also be performed using the remote controller.

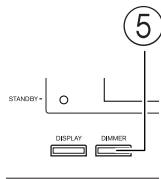

6 LISTENING MODE buttons [49-51]

Press these buttons to select a listening mode for the current input source. Press the DIRECT, STEREO, and SURROUND buttons to select a listening mode directly. Press the DSP button to select any of the possible listening modes for the input source currently selected.

Note:

During playback of a multichannel source, press the DIRECT button to turn off the tone control and the SURROUND button to turn on the tone control. [48]

7 Front display

8 MEMORY button [41]

Press to assign the radio station that you are currently tuned into to a preset channel or press to delete a previously preset station.

9 FM MODE button [40]

Press to change the stereo mode from AUTO to MONO and vice versa. Each time this button is pressed, the AUTO indication turns on and off indicating the current mode. If you are listening to an FM radio station in stereo and the sound cuts out or there is a great deal of noise, switch from AUTO to MONO.

10 Remote control sensor [7]

11 AUDIO ADJUST button [57]

Press to adjust the sound quality and the listening mode.

12 MENU button [36]

Press to enter the Setup Menu. The OSD Menu will appear on the TV monitor as well as the front display on the TX-SR700/700E/600/600E.

13 RETURN button [36]

When in the Setup Menu, press to go back one level. If pressed while at the Main Menu, you will exit the Setup Menu.

14 TUNING ▲/▼, PRESET ◀/▶, cursor (▲/▼/◀/▶) buttons [36, 40, 41]

To tune into a radio station, press the TUNING ▲/▼ buttons. The tuner frequency is displayed in the front display and it can be changed in 50-kHz increments for FM and 10-kHz (or 9-kHz) increments for AM.

When FM is selected as the input source, you can hold down either the TUNING ▲ or ▼ button and then release it to activate the auto-search feature. It will search for a station in the direction of the button you pressed and stop when it tunes into one. When navigating through the menu settings, these buttons move the cursor up or down (or change the highlighted item).

To select a radio station that was stored using the MEMORY button, press the PRESET ◀/▶ buttons.

When navigating through the menu settings, these buttons select the value or item that you selected with the TUNING ▲/▼ buttons.

When you press the MENU button, the TUNING and PRESET buttons become cursor buttons to be used for Setup Menu operations.

15 ENTER button [36]

Press to display the screen for the item that is selected in the Setup Menu.

16 MASTER VOLUME dial [44, 45]

TX-SR600/600E:

Use to control the volume.

TX-SR700/700E:

Use to control the volume in the main zone. The volume for the remote zone (Zone 2) is independent.

17 VIDEO 4 INPUT terminals [21, 28]

For connecting a video camera or game device.

The VIDEO 4 INPUT (DIGITAL)

jack is provided with a protective cap.

When using this jack, remove the protective cap and keep it safely.

When not using this jack, replace the protective cap.

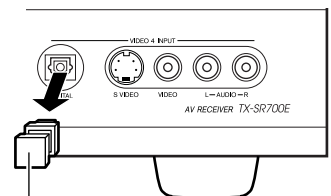

Protective cap

Front panel facilities

18 Input source buttons (DVD, VIDEO 1–4, TAPE, TUNER, PHONO (TX-SR700/700E only), and CD) [44, 45, 53]

TX-SR600/600E:

These buttons are used to select the input source.

TX-SR700/700E:

Press these buttons to select the input source for the main zone.

To select the input source for the remote zone (Zone 2) or recording out (Rec Out), first press the ZONE 2 or REC OUT button, and then press the desired input source button. The input channel with its indicator lit red is output to REC OUT and the one with its indicator lit green is output to ZONE 2.

19 AUDIO SELECTOR button [47]

Press to select the type of audio input signal.

20 PURE AUDIO button and indicator (TX-SR700/700E only) [49, 51]

Press to select the Pure Audio mode.

The PURE AUDIO indicator lights during pure audio playback.

21 PHONES jack [47]

This is a standard stereo jack for connecting stereo headphones.

22 REC OUT, ZONE 2, OFF, LEVEL ▲/▼ buttons, and ZONE 2 indicator (TX-SR700/700E only) [60, 61]

The REC OUT and ZONE 2 buttons allow you to use the TX-SR700/700E to output to a remote zone (Zone 2) or to another component for recording (Rec Out). Press the REC OUT button to output the audio and video signals to a recording component for recording. Press the ZONE 2 button to enjoy the output from the TX-SR700/700E in a different room, which is referred to as the remote zone (Zone 2). When either button is pressed, the currently selected input source for recording or outputting to the remote zone is displayed in the front panel display. If “SOURCE” is displayed, then the same input source as that selected for the main zone will be output.

To select an input source, press the desired button (REC OUT or ZONE 2) and then press one of the input source button within 5 seconds. That source will be output for recording or viewing in the remote zone.

To set the output to the source channel, press the desired button (REC OUT or ZONE 2) twice in succession. To turn off the output, press the OFF button. The ZONE 2 indicator lights when a signal is output to the remote zone (Zone 2). When the ZONE 2 indicator is off, then either output to the remote zone is turned off or Rec Out is selected. Press the LEVEL ▲/▼ buttons to enter the mode for adjusting the volume in the remote zone (Zone 2).

Note:

The Rec Out and Zone 2 buttons use the same circuit and therefore cannot be used at the same time. When REC OUT is selected, nothing is output to Zone 2. When ZONE 2 is selected, REC OUT is automatically fixed to SOURCE.

23 SPEAKERS A/B buttons (TX-SR600/600E only) [45]

Press these buttons to turn on and off speakers systems A and B.

Front panel facilities

Front panel display

<TX-SR700E>

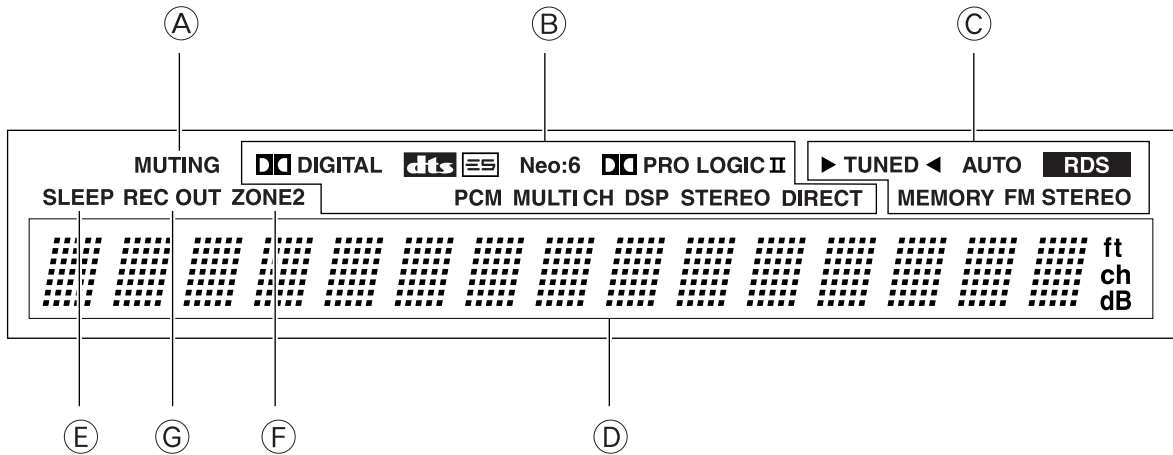

<TX-SR600E>

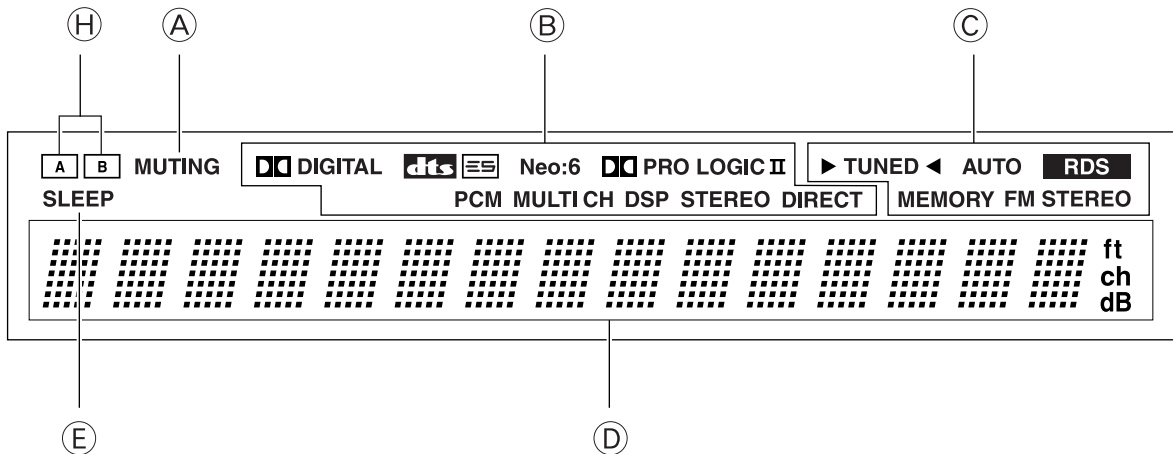

Ⓐ MUTING indicator

Flashes when the mute function is turned on.

Ⓑ Listening mode or digital input format indicators

One of these indicators lights to show the format of the current input source. In addition, one of the listening mode indicators lights to indicate the current listening mode.

Ⓒ Tuning indicators

TUNED indicator

Lights when a radio station is received.

AUTO indicator

Lights when receiving FM broadcasts in the stereo mode. Turns off when placed into the monaural mode.

RDS indicator (European models only)

Lights when an RDS station is received.

MEMORY indicator

Lights when the MEMORY button is pressed to preset a radio station.

FM STEREO indicator

Lights when an FM broadcast station is received in stereo.

Ⓓ Multi function display

During normal operation, shows the current input source and volume. When the FM or AM input is selected, shows the frequency and preset number. When the DISPLAY button is pressed, shows the listening mode and input source format. However, does not show the source format when the FM or AM source is selected.

Ⓔ SLEEP indicator

Lights when the sleep timer is turned on.

Ⓕ ZONE 2 indicator (TX-SR700/700E only)

Lights when using the remote zone (Zone 2).

Ⓖ REC OUT indicator (TX-SR700/700E only)

Lights when recording the input source from one component to another (Rec Out).

Ⓗ SPEAKERS A/B indicators (TX-SR600/600E only)

Indicates which speaker system is currently in use.

Remote controller

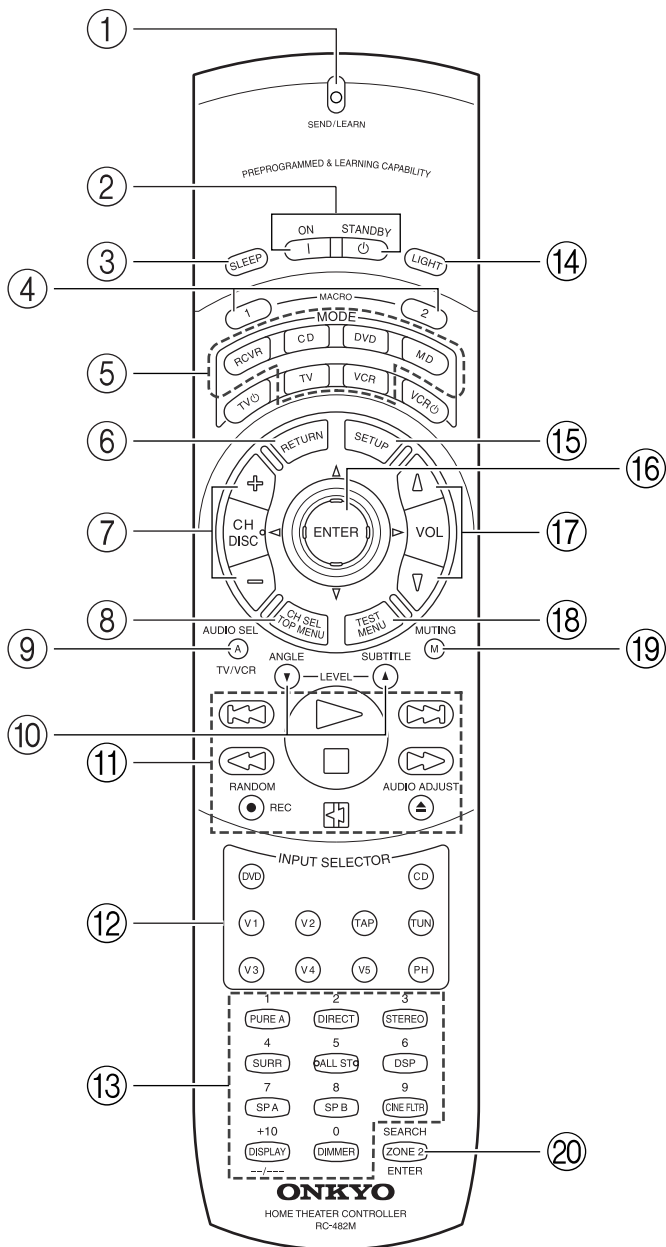

1 SEND/LEARN indicator

Lights red when signals are sent by the remote controller. It also flashes when a button is pressed when the battery power is low.

2 ON/STANDBY button [33]

ON: Press to turn on the TX-SR700/700E/600/600E.

STANDBY: Press to place the TX-SR700/700E/600/600E in the standby state.

Be aware that pressing the STANDBY button only places the TX-SR700/700E/600/600E in standby and does not turn the power completely off.

3 SLEEP button [47]

Press to set the sleep function.

The SLEEP button enables you to set the TX-SR700/700E/600/600E to turn off automatically after a specified time period.

4 MACRO 1, 2 button [73]

Press to program or execute the macro function.

5 MODE buttons and indicators [44, 45, 64-66]

Press to select the component to be operated by the remote controller. When a MODE button is pressed, it will light green for 8 seconds. The selected MODE button will also light whenever any other operation button is pressed.

6 RETURN button [36]

Press to enter the selected setting and return to the previous menu.

7 CH +/-, DISC +/- button

Press to select a preset channel for the tuner (CH). [41]

When the CD mode is selected, also press to select a disc when operating components with disc changers (DISC). [64]

8 CH SEL/TOP MENU button

Press to select a speaker channel when adjusting the speaker level (CH SEL). [39]

When the DVD mode is selected, press to display the menu screens of the DVD player (TOP MENU). [65]

9 AUDIO SEL/TV/VCR button [47]

Press to select the audio input signal. The setting changes from "Auto" to "Multich" (only if DVD is selected as the input source) to "Analog" and back each time this button is pressed.

10 LEVEL ▼/ANGLE and LEVEL ▲/SUBTITLE buttons

Press to adjust the volume of the speaker selected using the CH SEL button (LEVEL ▼/▲). [39]

Press the ANGLE button to select a camera angle when playing a DVD-Video with multiple angle playback.

Press the SUBTITLE button to select a subtitle language when playing a DVD-Video. [65]

11 CD/TAPE/DVD/MD operation buttons [63-66]

Press to operate other Onkyo components connected to the TX-SR700/700E/600/600E using the **RL** terminals.

Remote controller

⑫ INPUT SELECTOR buttons [44, 45, 53]

Press to select an input source.

Same as the input selector buttons on the front panel of the TX-SR700/700E/600/600E. The input source for each button is given here. DVD:DVD, CD:CD, V1:VIDEO1, V2:VIDEO2, V3:VIDEO3, V4:VIDEO4, V5:VIDEO5 (not used with the TX-SR700/700E/600/600E), TAP:TAPE, TUN:FM/AM, PH:PHONO (not used with the TX-SR600/600E).

⑬ Numeric key/Listening mode, SP A, SP B, CINE FLTR, DISPLAY, DIMMER buttons

1 to 9, +10, --/--, 0: For entering the number of a track. [64-66]

PURE A:

TX-SR600/600E: Not used with the TX-SR600/600E.

TX-SR700/700E: Press to select the Pure Audio mode. [51]

DIRECT, STEREO, SURR, ALL ST, DSP: You can select a listening mode. [51]

Note:

During playback of a multichannel source, press the DIRECT button to turn off the tone control and the SURR button to turn on the tone control.

SP A, SP B:

TX-SR600/600E: Switches between speakers A and B.

TX-SR700/700E: Not used with the TX-SR700/700E.

CINE FLTR: Depending on the listening mode, you can turn the CinemaFILTER function on or off. [52]

DISPLAY: For changing the display in the front display. [48]

DIMMER: Adjusts the display brightness.

There are three settings available: normal, dark, and very dark.

⑭ LIGHT button (RC-482M only)

Press to turn on and off the lights in the buttons of the remote controller.

⑮ SETUP button [36]

Press to display the Setup Menu on the TV screen and in the display. Press again to exit the menu.

⑯ ▲/▼/◀/▶, ENTER button [36]

When in the Setup Menu, press the upper and lower arrow buttons to select an item, press the right and left arrow buttons to select parameter values or modes, and press the ENTER button to advance to the next item.

⑰ VOL Δ/∇ button [44, 45]

Press to adjust the volume.

⑱ TEST/MENU button

This button is used to set the speaker output levels. Use this button in conjunction with the LEVEL ▲/▼ and CH SEL buttons to calibrate the speakers levels without entering the Setup Menu. [39]

When the DVD mode is selected, press to display the DVD menu (MENU). [65]

⑲ MUTING button [48]

Press to activate the mute function.

⑳ ZONE 2/SEARCH/ENTER button

When the DVD mode is selected, press to find the specific section on a DVD where you want to start playback (SEARCH). [65]

When in the RCVR mode, press to perform operations on the remote zone (ZONE 2) (not used with the TX-SR600/600E). [60]

When in the MD mode, press to enter the selected song (ENTER). [66]

Connections

- Be sure to always refer to the instructions that came with the component that you are connecting.
- Do not plug in the power cord until all connections have been properly made.
- For input jacks, red connectors (marked R) are used for the right channel, white connectors (marked L) are used for the left channel, and yellow connectors (marked V) are used for video connection.
- Insert all plugs and connectors securely. Improper connections can result in noise, poor performance, or damage to the equipment.

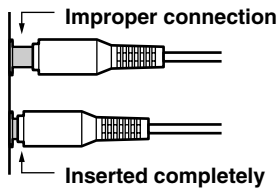

- Do not bind audio/video connection cables with power cords and speaker cables. Doing so may adversely affect the picture and sound quality.

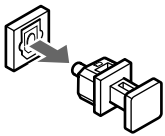

Optical digital terminals

The optical digital terminals are provided with protection caps. Before you connect a cable to a terminal, remove the cap and keep it safely. If you disconnect the cable, put the cap back on the terminal.

Cables are depicted in the connection diagrams as shown below.

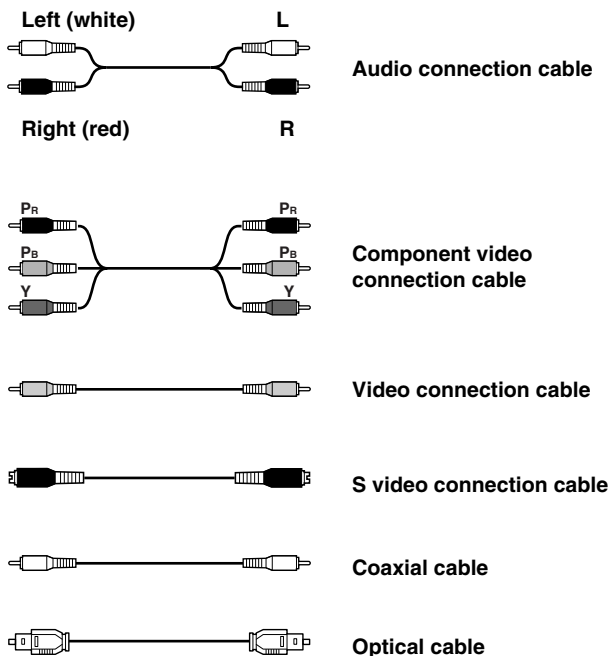

Connections

TX-SR700/700E

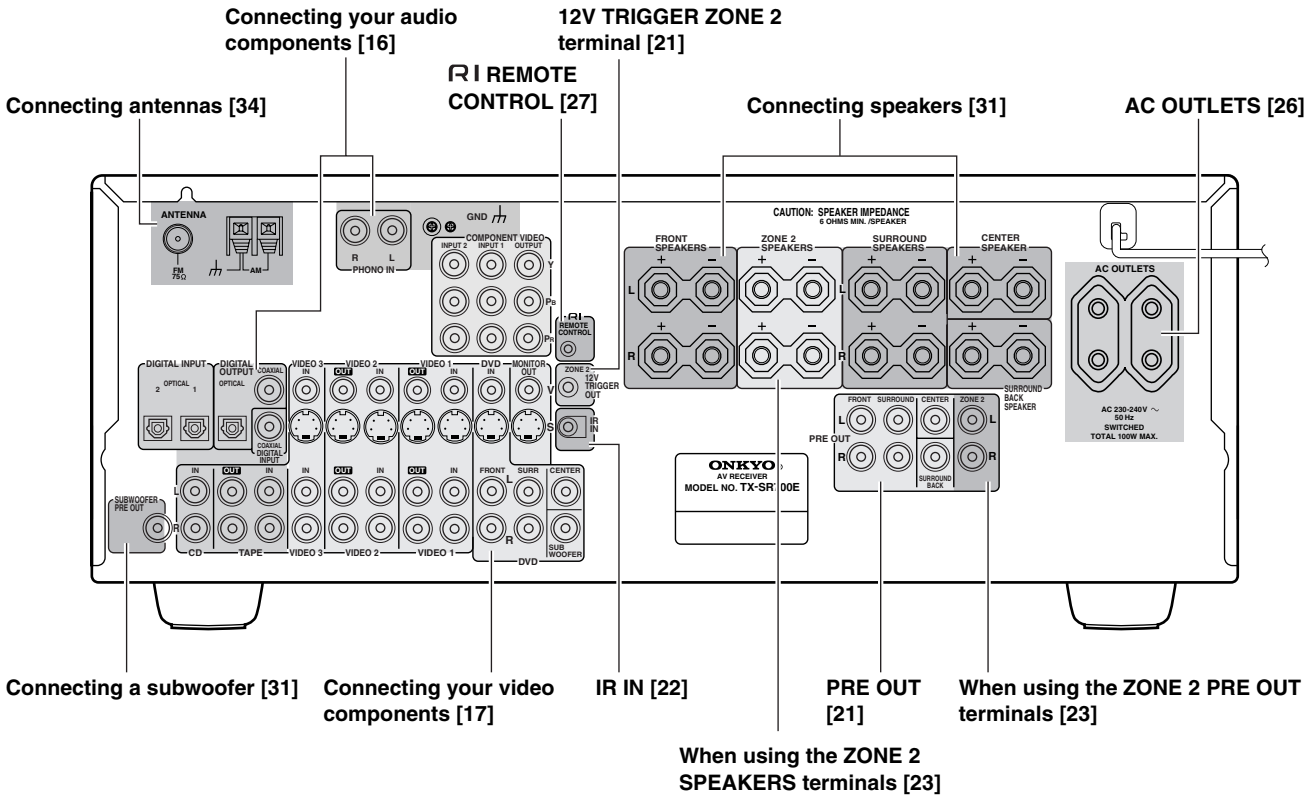

TX-SR600/600E

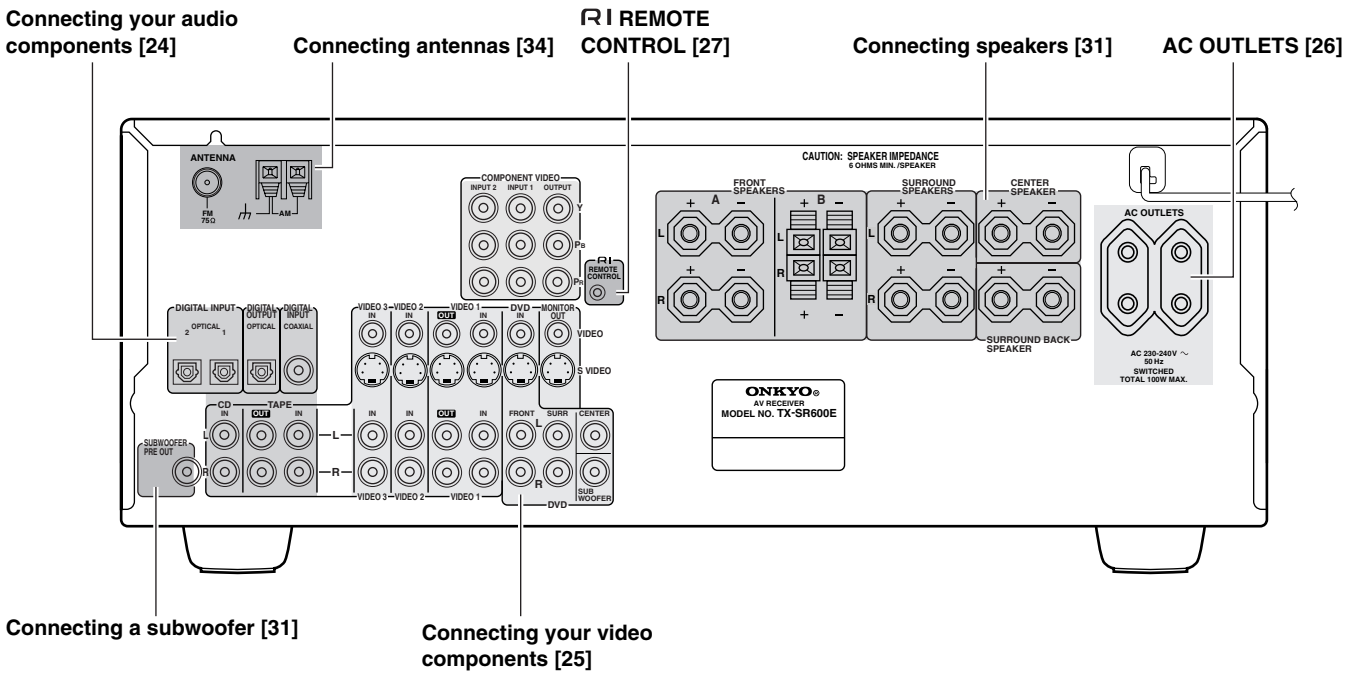

Connections (TX-SR700/700E)

Here is an explanation of typical ways to connect various components to the TX-SR700/700E. There are many ways that any one component can be connected, and it is up to you to decide which method best fits your situation. The directions given here are only one option and should only be thought of as such. It is best to fully understand the nature of each connector and terminal as well as those of your components and their features to ascertain which method of connection is best.

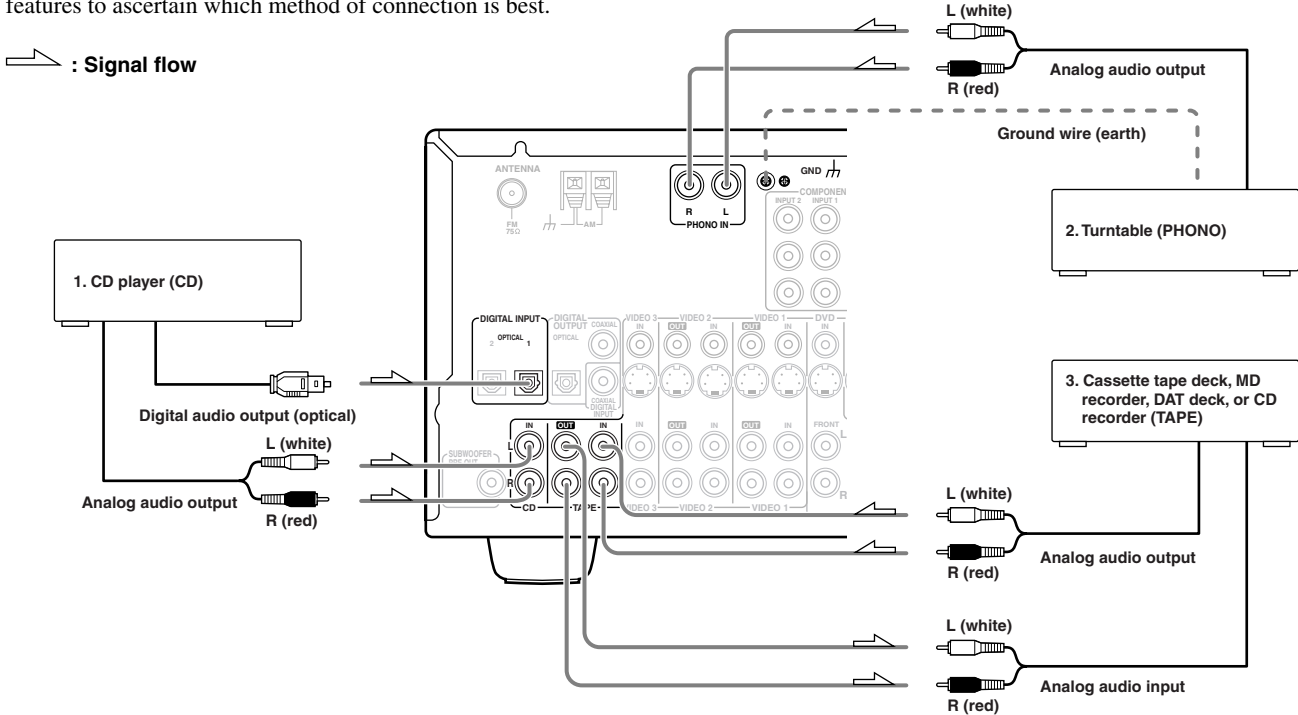

Connecting your audio components

Below is an example of how you can connect your audio components to the TX-SR700/700E. Refer to the diagram above for the following connection examples.

AUDIO IN/OUT

These are the analog audio inputs and outputs. There are seven audio inputs and three audio outputs on the rear panel. The audio inputs and outputs require RCA-type connectors.

DIGITAL INPUT/OUTPUT

On the rear panel of the TX-SR700/700E, there are one coaxial digital input, two optical digital inputs, one coaxial digital output, and one optical digital output. To the digital inputs, connect CD players, LD players, DVD players, or other digital source component. To the digital outputs, connect MD recorders, CD recorders, DAT decks, or other similar components.

- Since an analog connection must be made when using REC OUT or ZONE 2, make sure that the connection to the input source is not digital only, but analog as well.
- When using an optical input or output jack, always use an optical fiber cable.

1. Connecting a compact disc player (CD)

Using an RCA audio cable, connect the output jacks of the compact disc player to the CD audio jacks of the TX-SR700/700E. Make sure that you properly connect the left channel to the L jack and the right channel to the R jack.

If the compact disc player has a digital output, connect it to either the DIGITAL INPUT COAXIAL jack or the DIGITAL INPUT OPTICAL jack of the TX-SR700/700E depending on the type of connector on the compact disc player.

With the initial settings of the TX-SR700/700E, the CD input source is set for digital input at the OPTICAL 1 jack (OPT 1).

If the digital connection is made to a different jack, this must be changed at "Input Setup" → "Digital Input" (see page 53).

2. Connecting a turntable (PHONO)

Using an RCA audio cable, connect the output jacks of the turntable to the PHONO audio jacks of the TX-SR700/700E. Make sure that you properly connect the left channel to the L jack and the right channel to the R jack.

Note:

The TX-SR700/700E is designed for use with moving magnet cartridges. For proper operation, connect a ground (or earth) wire to the GND terminal. For some turntables, however, connecting the ground wire may cause increased noise, and in such a case, a ground wire is not necessary and should not be connected.

3. Connecting a cassette tape deck, MD recorder, DAT deck, or CD recorder (TAPE)

Using RCA audio cables, connect the output jacks (PLAY) of the device to the TAPE IN audio jacks of the TX-SR700/700E and connect the input jacks (REC) of the device to the TAPE OUT audio jacks of the TX-SR700/700E. Make sure that you properly connect the left channels to the L jacks and the right channels to the R jacks. If the device has a digital output, connect it to either the DIGITAL INPUT COAXIAL jack or the DIGITAL INPUT OPTICAL jack of the TX-SR700/700E depending on the type of connector on the device.

With the initial settings of the TX-SR700/700E, nothing is allocated as the digital input source for TAPE (---).

If you connect the digital audio output, be sure to make the appropriate changes at "Input Setup" → "Digital Input" (see page 53).

If the device has a digital input, connect it to the DIGITAL OUTPUT (OPTICAL or COAXIAL) jack of the TX-SR700/700E for digital recording of the signal from the digital input of the TX-SR700/700E.

Note:

The output from the DIGITAL OUTPUT jack of the TX-SR700/700E is only the digital signal input to the DIGITAL INPUT jack.

Connections (TX-SR700/700E)

Connecting a DVD Player with 5.1-Channel Output

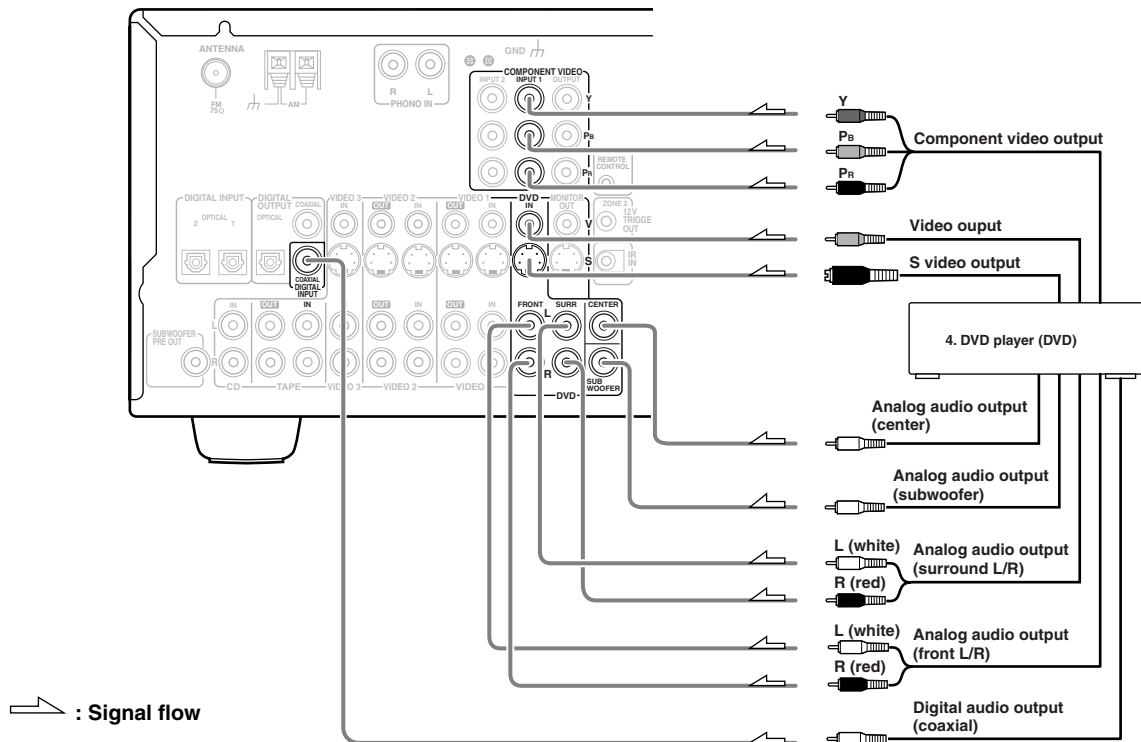

Connecting your video components

Below is an example of how you can connect your video components to the TX-SR700/700E. Refer to the diagram above for the following connection examples.

COMPONENT VIDEO INPUT/OUTPUT

For DVD players or other devices that have component video connectors, the TX-SR700/700E has two banks of component video input connectors (Y, PB, PR) for direct component video input. The TX-SR700/700E also has one bank of component video output connectors for direct component video output to the matrix decoder of a television, projector, or other display device. By sending the pure component video signal directly, the signal forgoes the extra processing that normally would degrade the image. The result is vastly increased image quality, with incredibly lifelike colors and crisp detail.

- The signal that comes in from COMPONENT VIDEO INPUT is only sent to COMPONENT VIDEO OUTPUT. When connecting a video player to the COMPONENT VIDEO INPUT jacks, be sure to connect your television to the COMPONENT VIDEO OUTPUT jacks.

VIDEO IN/OUT

These are the video inputs and outputs. On the rear panel, there are four video inputs and two video outputs and each one includes both composite video and S video configurations.

Connect VCRs, VTRs, LD players, DVD players, and other video components to the video inputs. Connect VCRs, VTRs, and other recording components to the video outputs to make video recordings.

- When connecting a VCR or other video component, make sure you connect its audio and video leads to the same bank (e.g., both to VIDEO 3).
- The VIDEO 4 inputs are located on the front panel.

The flow of the video signals is as follows:

The signal that comes in from a VIDEO IN jack is sent to both the VIDEO OUT and S VIDEO OUT jacks. The signal that comes in from a S VIDEO IN jack is sent to both the S VIDEO OUT and VIDEO OUT jacks. It is not necessary to make both video and S VIDEO connections.

Notes:

- If your video output device (e.g., television or projector) is connected only to the MONITOR OUT VIDEO jack, MONITOR OUT S VIDEO jack, or both, and the video signal from the source component is input through the component video connectors, no picture will appear. Video sources input from the component video connectors can only be output from the component video connectors.
- For more information about the DIGITAL INPUT/OUTPUT jacks, see page 16.

Connections (TX-SR700/700E)

Connecting a DVD Player with 2-Channel (L/R) Audio Output

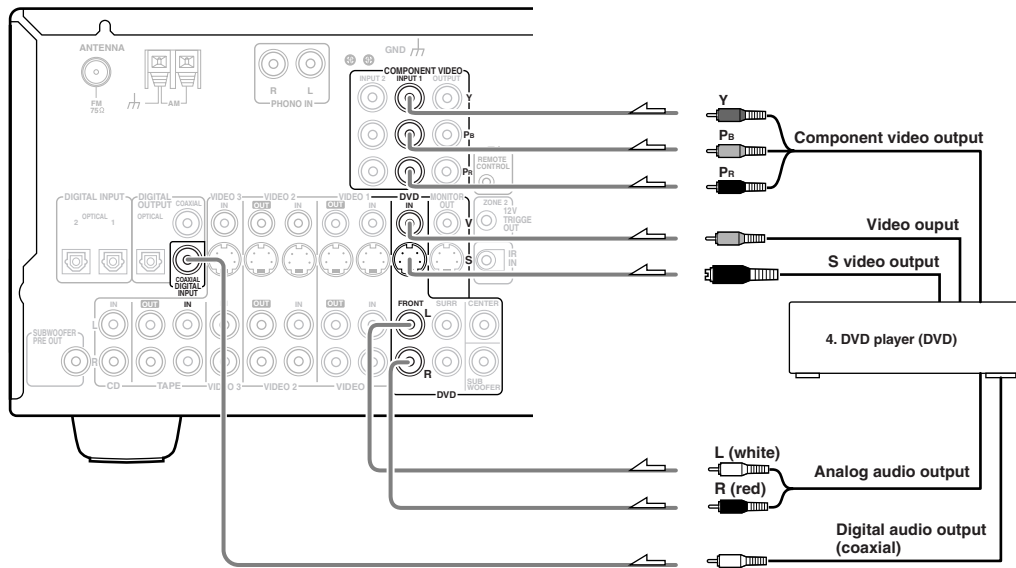

 : Signal flow

4. Connecting a DVD player (DVD)

Using an RCA video cable, connect the video output jack (composite) of the DVD player to the DVD VIDEO IN jack of the TX-SR700/700E. Or if the DVD player has an S video output jack, connect it to the DVD S VIDEO IN jack with an S video cable. Or if the device has component video outputs, connect them to the COMPONENT VIDEO INPUT 1 or 2 jacks on the TX-SR700/700E.

With the initial settings of the TX-SR700/700E, the DVD input source is set for the COMPONENT VIDEO INPUT 1 jacks.

If you connect the DVD player to the COMPONENT VIDEO INPUT 2 jacks, this must be changed at “Input Setup” → “Component Video” (see page 54).

Using an RCA audio connection cable, connect the audio output jacks of the DVD player to the DVD FRONT L/R jacks of the TX-SR700/700E. Make sure that you properly connect the left channel to the L jack and the right channel to the R jack.

If the device has a 5.1-channel output, connect the DVD FRONT L/R, SURR L/R, CENTER, and SUBWOOFER (5.1-channel input) jacks of the TX-SR700/700E to the 5.1-channel output jacks of the DVD player. Make sure that you properly connect the left channels to the L jacks and the right channels to the R jacks.

If the device has a digital output, connect it to either the DIGITAL INPUT COAXIAL jack or the DIGITAL INPUT OPTICAL jack of the TX-SR700/700E depending on the type of connector on the DVD player.

With the initial settings of the TX-SR700/700E, the DVD input source is set for digital input at the COAXIAL jack (COAX).

If the digital connection is made at a different jack, this must be changed at “Input Setup” → “Digital Input” (see page 53).

Note:

If the DVD player has both 5.1-channel audio outputs and 2-channel audio outputs, and you want to connect the DVD player only using the FRONT L/R jacks on the TX-SR700/700E, use the 2-channel audio output jacks on the DVD player.

Connections (TX-SR700/700E)

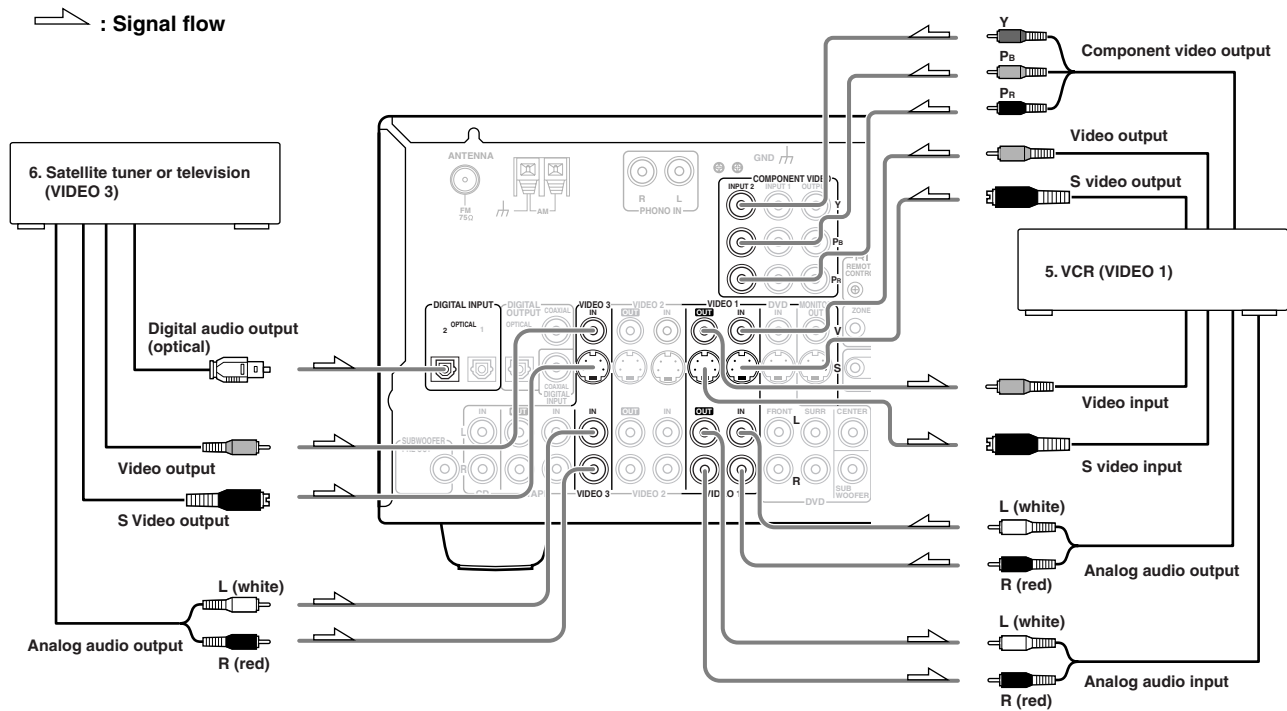

5. Connecting a video cassette recorder (VIDEO 1)

Using RCA video cables, connect the video output jack (composite) of the video cassette recorder to the VIDEO 1 VIDEO IN jack of the TX-SR700/700E and connect the video input jack of the video cassette recorder to the VIDEO 1 VIDEO OUT jack of the TX-SR700/700E. Or if the video cassette recorder has S video input and output jacks, using S video cables, connect the S video output jack of the video cassette recorder to the VIDEO 1 S VIDEO IN jack of the TX-SR700/700E and connect the video input jack of the video cassette recorder to the VIDEO 1 S VIDEO OUT jack of the TX-SR700/700E. Or if the video cassette recorder has component video outputs, connect them to the COMPONENT VIDEO INPUT 1 or 2 jacks on the TX-SR700/700E.

With the initial settings of the TX-SR700/700E, the VIDEO 1 input source is set for the COMPONENT VIDEO INPUT 2 jacks.

If you connect the video cassette recorder to the COMPONENT VIDEO INPUT 1 jacks, this must be changed at “Input Setup” → “Component Video” (see page 54).

Using RCA audio cables, connect the audio output jacks of the video cassette recorder to the VIDEO 1 IN audio jacks of the TX-SR700/700E and connect the audio input jacks of the video cassette recorder to the VIDEO 1 OUT audio jacks of the TX-SR700/700E. Make sure that you properly connect the left channels to the L jacks and the right channels to the R jacks.

With the initial settings of the TX-SR700/700E, nothing is allocated as the digital input source for VIDEO 1 (----).

If you connect the digital audio output, be sure to make the appropriate changes at “Input Setup” → “Digital Input” (see page 53).

6. Connecting a satellite tuner, television, or settop box (VIDEO 3)

Using an RCA video cable, connect the video output jack (composite) of the device to the VIDEO 3 VIDEO IN jack of the TX-SR700/700E. Or if the device has an S video output jack, connect it to the VIDEO 3 S VIDEO IN jack of the TX-SR700/700E using an S video cable. Or if the device has component video outputs, connect them to the COMPONENT VIDEO INPUT 1 or 2 jacks on the TX-SR700/700E.

With the initial settings of the TX-SR700/700E, the VIDEO 3 input source is set for the COMPONENT VIDEO INPUT 2 jacks.

If you connect the device to the COMPONENT VIDEO INPUT 1 jacks, this must be changed at “Input Setup” → “Component Video” (see page 54).

Using an RCA audio cable, connect the audio output jack of the device to the VIDEO 3 IN audio jacks of the TX-SR700/700E. Make sure that you properly connect the left channel to the L jack and the right channel to the R jack.

If the device has a digital output, connect it to either the DIGITAL INPUT COAXIAL jack or the DIGITAL INPUT OPTICAL jack of the TX-SR700/700E depending on the type of connector on the device.

With the initial settings of the TX-SR700/700E, the VIDEO 3 input source is set for digital input at the OPTICAL 2 jack (OPT 2).

If the digital connection is made at a different jack, this must be changed at “Input Setup” → “Digital Input” (see page 53).

Connections (TX-SR700/700E)

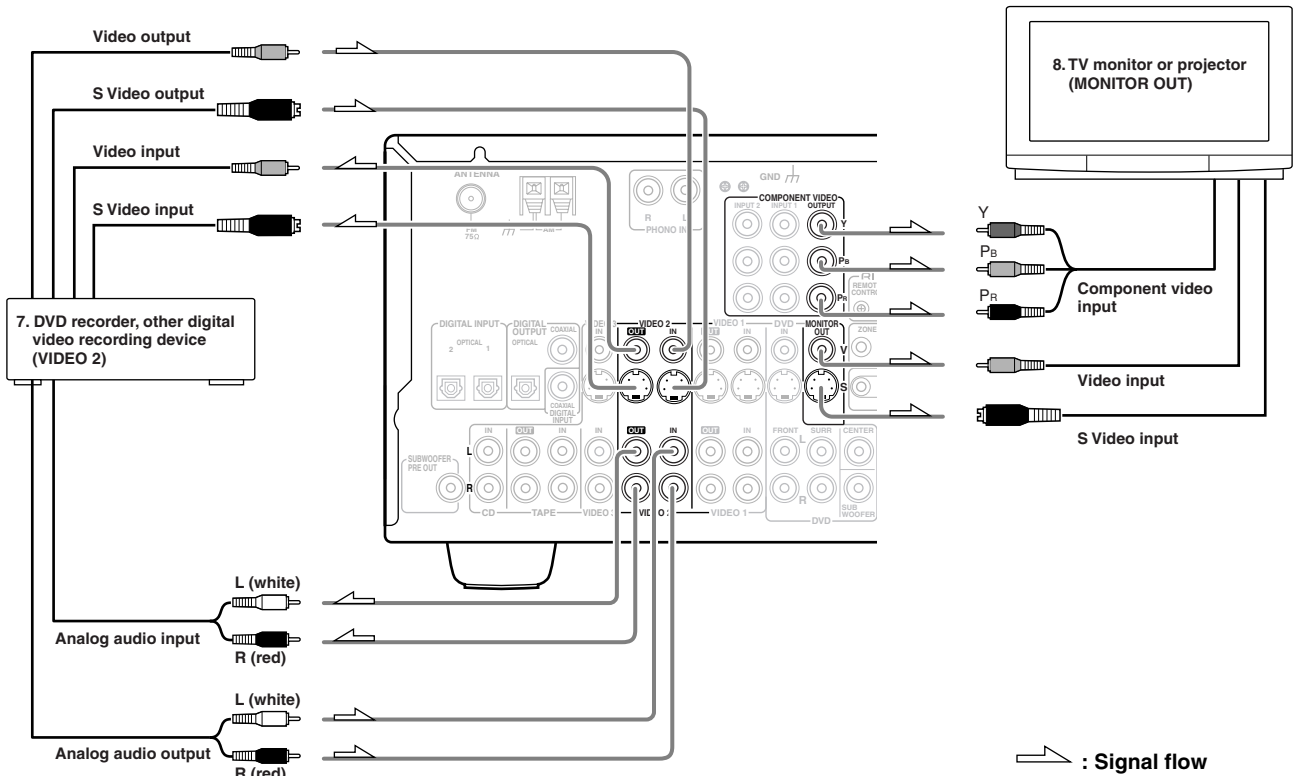

7. Connecting a DVD recorder or other digital video recording device (VIDEO 2)

Using RCA video cables, connect the video output jack (composite) of the device to the VIDEO 2 VIDEO IN jack of the TX-SR700/700E and connect the video input jack of the device to the VIDEO 2 VIDEO OUT jack of the TX-SR700/700E. Or if the device has S video input and output jacks, using S video cables, connect the S video output jack of the device to the VIDEO 2 S VIDEO IN jack of the TX-SR700/700E and connect the video input jack of the device to the VIDEO 2 S VIDEO OUT jack of the TX-SR700/700E. Or if the device has component video outputs, connect them to the COMPONENT VIDEO INPUT 1 or 2 jacks on the TX-SR700/700E.

With the initial settings of the TX-SR700/700E, the VIDEO 2 input source is set for the COMPONENT VIDEO INPUT 2 jacks.

If you connect the device to the COMPONENT VIDEO INPUT 1 jacks, this must be changed at “Input Setup” → “Component Video” (see page 54).

Using RCA audio cables, connect the audio output jacks of the device to the VIDEO 2 IN audio jacks of the TX-SR700/700E and connect the audio input jacks of the device to the VIDEO 2 OUT audio jacks of the TX-SR700/700E. Make sure that you properly connect the left channels to the L jacks and the right channels to the R jacks.

If the device has a digital output, connect it to either the DIGITAL INPUT COAXIAL jack or the DIGITAL INPUT OPTICAL jack of the TX-SR700/700E depending on the type of connector on the device.

With the initial settings of the TX-SR700/700E, nothing is allocated as the digital input source for VIDEO 2 (----).

If you connect the digital audio output, be sure to make the appropriate changes at “Input Setup” → “Digital Input” (see page 53).

If the device has a digital input, connect it to the DIGITAL OUTPUT (OPTICAL or COAXIAL) jack of the TX-SR700/700E for digital recording of the signal from the digital input of the TX-SR700/700E.

Note:

The output from the DIGITAL OUTPUT jack of the TX-SR700/700E is only the digital signal input to the DIGITAL INPUT jack.

8. Connecting a television monitor or projector (MONITOR OUT)

The TX-SR700/700E is equipped with a simple Y/C separate circuit and simple Y/C mixed circuit. Since both the signal from the S VIDEO and VIDEO inputs are output to the MONITOR OUT S VIDEO output, if the television or projector is equipped with an S video input, it is unnecessary to connect the video connectors. If it is equipped with only a video input, connect it to the MONITOR OUT VIDEO output.

Using an RCA video cable, connect the video input jack (composite) of the device to the MONITOR OUT VIDEO jack of the TX-SR700/700E. Or if the device has an S video input jack, connect it to the MONITOR OUT S VIDEO jack of the TX-SR700/700E using an S video cable. Or if the device has component video inputs, connect them to the bank of COMPONENT VIDEO OUTPUT jacks on the TX-SR700/700E.

Note:

Note that the Setup Menu will only be displayed on the monitor connected to MONITOR OUT and not those connected to the COMPONENT VIDEO OUTPUT jacks.

Connections (TX-SR700/700E)

9. Connecting video camera, etc. (VIDEO 4 INPUT)

Using an RCA video cable, connect the video output jack (composite) of the device to the VIDEO 4 VIDEO jack of the TX-SR700/700E. Or if the device has an S video output jack, connect it to the VIDEO 4 S VIDEO jack of the TX-SR700/700E using an S video cable.

Using an RCA audio cable, connect the audio output jack of the device to the VIDEO 4 AUDIO jacks of the TX-SR700/700E. Make sure that you properly connect the left channel to the L jack and the right channel to the R jack.

If the device has an optical digital output, connect it to the VIDEO 4 DIGITAL jack of the TX-SR700/700E.

The VIDEO 4 digital input is fixed to the OPTICAL input on the front panel.

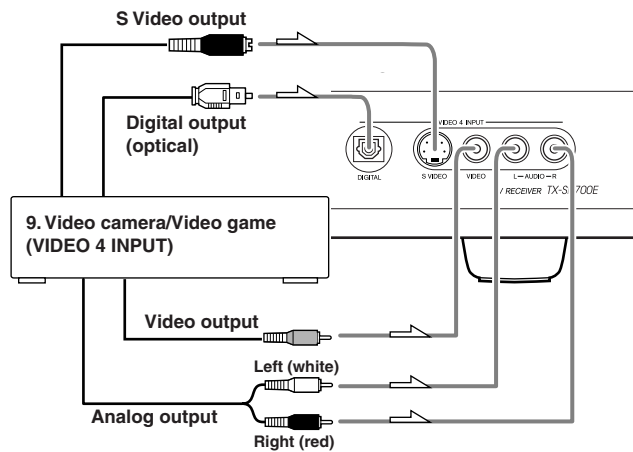

12V TRIGGER ZONE 2 terminal

When the TX-SR700/700E is in the ZONE 2 mode, this terminal outputs at 12 V/100 mA.

PRE OUT

These jacks are for connecting an auxiliary power amplifier. You can use an auxiliary power amplifiers to listen at louder volumes than you can with the TX-SR700/700E alone. When using a power amplifier, connect each speaker to the power amplifier.

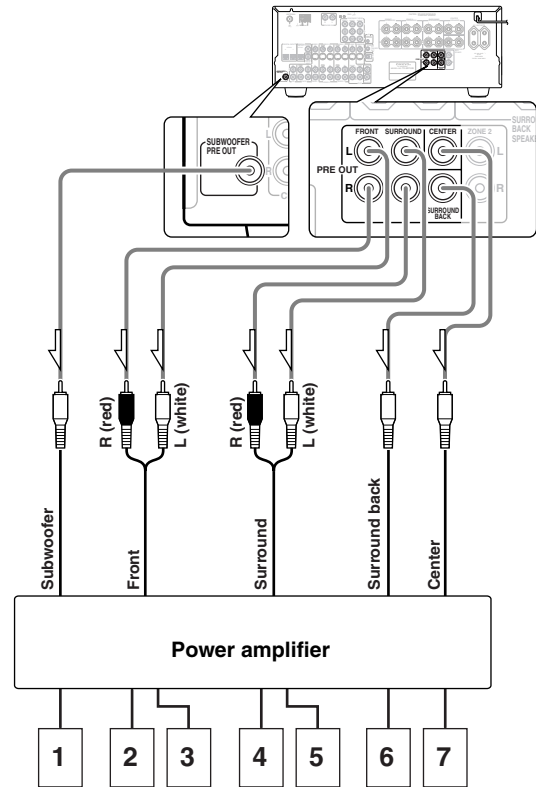

- | | |
|---------------------------|--------------------------|
| 1. Subwoofer | 5. Surround left speaker |
| 2. Front right speaker | 6. Surround back speaker |
| 3. Front left speaker | 7. Center speaker |
| 4. Surround right speaker | |

Operating components not reached by the remote controller signals (IR IN) (TX-SR700/700E only)

In order to use the remote controller to control the TX-SR700/700E from a remote location, you will need to prepare a multi-room kit (sold separately) such as one of those given below:

- Onkyo's Multi-Room System kit (IR Remote Controller Extension System)
- Multiroom A/V distribution and control system such as those from Niles® and Xantech®

If the remote controller signal does not reach the TX-SR700/700E remote sensor

If the TX-SR700/700E is located inside a cabinet or other enclosure where the infrared rays from the remote controller cannot enter, then operation with the remote controller will not be possible. In such a case, it will be necessary to install a remote sensor at a location outside of the cabinet where the infrared rays from the controller can reach.

With this connection, select "Main" at "Preference" → "IR IN Position" (see page 56).

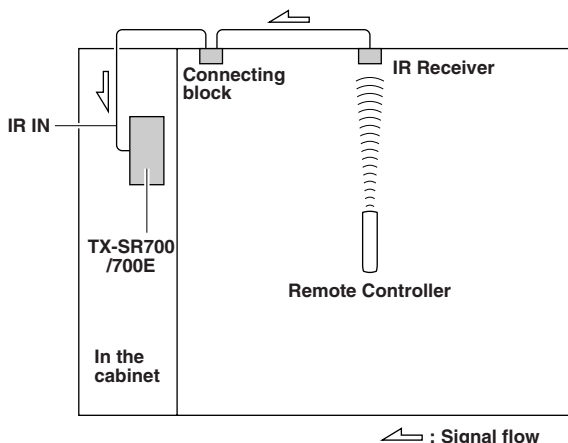

Make the connections as shown below. Do not plug in any equipment to the power outlet until all the connections are complete.

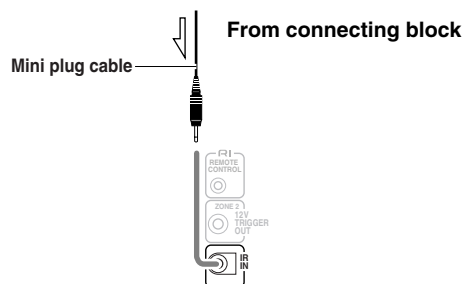

TX-SR700/700E

The IR IN input allows you to control the TX-SR700/700E from the remote zone (Zone 2) with the remote controller even though the remote zone may be on the other side of the building from the main zone. The diagram below shows how to make the proper connections for the remote zone.

With this connection, select "Zone 2" at "Preference" → "IR IN Position" (see page 56).

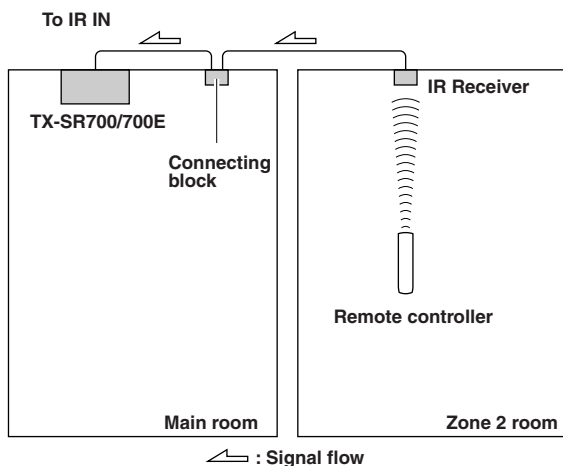

Connecting the remote zone (Zone 2) speakers

(TX-SR700/700E only)

The TX-SR700/700E allows you to listen to two separate input sources at the same time. This allows you to, for example, place speakers in two different rooms so that two or more people can enjoy two different kinds of music at the same time. The room where the TX-SR700/700E is actually located is referred to as the main room while the separate room is referred to as the remote zone (Zone 2). In addition, the IR IN terminal of the TX-SR700/700E allows you to control the TX-SR700/700E from the remote zone (Zone 2) with the remote controller even though the remote zone is physically separated. The diagram below shows how to make the proper connections for the remote zone.

When using the ZONE 2 SPEAKERS terminals

If you are using a 5.1-channel speaker system in the main room, you can connect the speakers for the remote zone (Zone 2) to the open ZONE 2 SPEAKERS terminals.

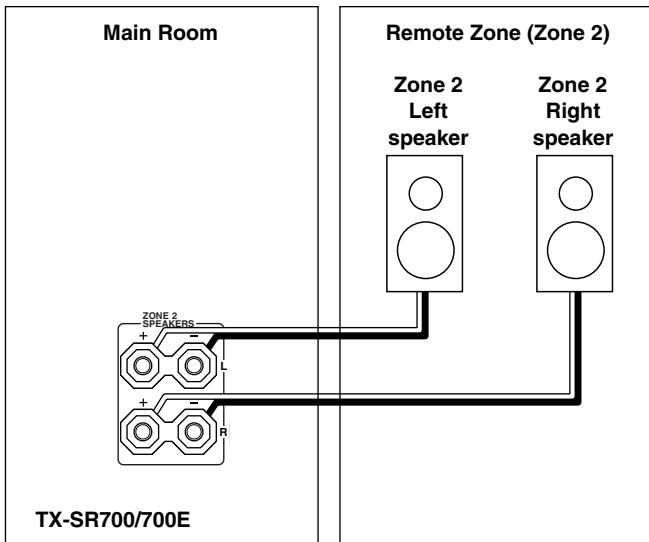

Note:

It is important to be aware of the speaker impedance (see page 31).

When using the ZONE 2 PRE OUT terminals

If you are using a 5.1-channel speaker system in the main room, you can connect the amplifier for the remote zone (Zone 2) to the open ZONE 2 PRE OUT terminals and connect the remote zone speakers.

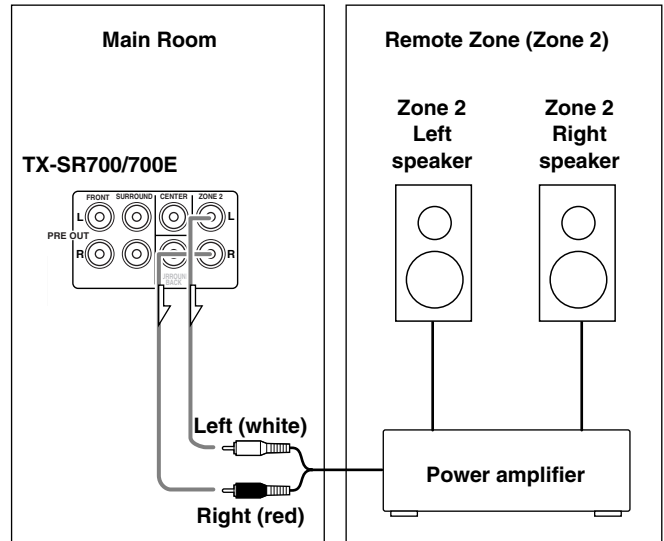

Connections (TX-SR600/600E)

Here is an explanation of typical ways to connect various components to the TX-SR600/600E. There are many ways that any one component can be connected, and it is up to you to decide which method best fits your situation. The directions given here are only one option and should only be thought of as such. It is best to fully understand the nature of each connector and terminal as well as those of your components and their features to ascertain which method of connection is best.

 : Signal flow

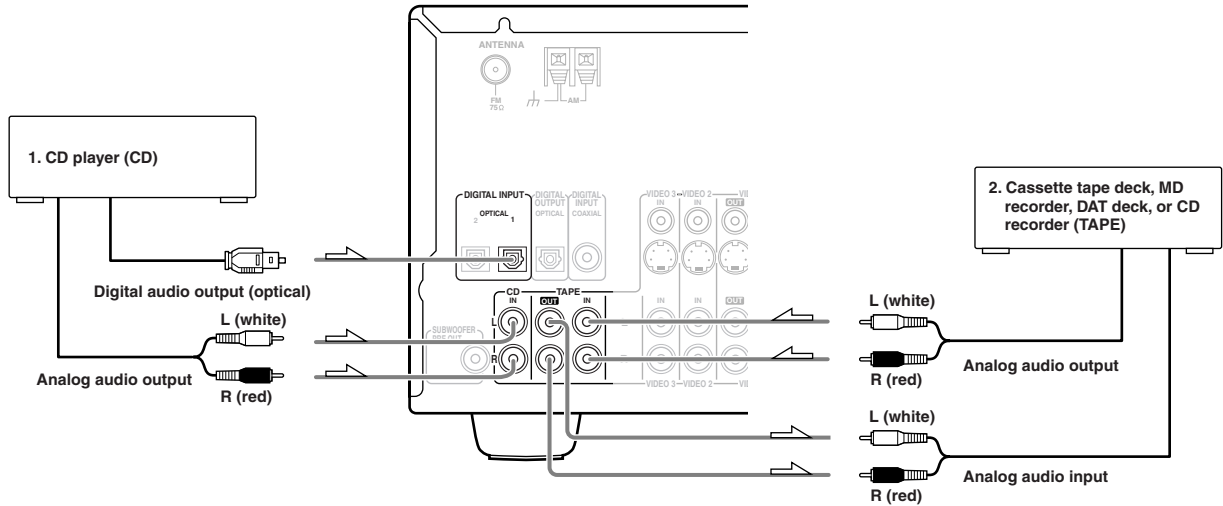

Connecting your audio components

Below is an example of how you can connect your audio components to the TX-SR600/600E. Refer to the diagram above for the following connection examples.

AUDIO IN/OUT

These are the analog audio inputs and outputs. There are six audio inputs and two audio outputs on the rear panel. The audio inputs and outputs require RCA-type connectors.

DIGITAL INPUT/OUTPUT

On the rear panel of the TX-SR600/600E, there are one coaxial digital input, two optical digital inputs, and one optical digital output. To the digital inputs, connect CD players, LD players, DVD players, or other digital source component. To the digital output, connect an MD recorder, CD recorder, DAT deck, or other similar component.

- Since an analog connection must be made when using REC OUT, make sure that the connection to the input source is not digital only, but analog as well.
- When using an optical input or output jack, always use an optical fiber cable.

1. Connecting a compact disc player (CD)

Using an RCA audio cable, connect the output jacks of the compact disc player to the CD audio jacks of the TX-SR600/600E. Make sure that you properly connect the left channel to the L jack and the right channel to the R jack.

If the compact disc player has a digital output, connect it to either the DIGITAL INPUT COAXIAL jack or the DIGITAL INPUT OPTICAL jack of the TX-SR600/600E depending on the type of connector on the compact disc player.

With the initial settings of the TX-SR600/600E, the CD input source is set for digital input at the OPTICAL 1 jack (OPT 1).

If the digital connection is made to a different jack, this must be changed at "Input Setup" → "Digital Input" (see page 53).

2. Connecting a cassette tape deck, MD recorder, DAT deck, or CD recorder (TAPE)

Using RCA audio cables, connect the output jacks (PLAY) of the device to the TAPE IN audio jacks of the TX-SR600/600E and connect the input jacks (REC) of the device to the TAPE OUT audio jacks of the TX-SR600/600E. Make sure that you properly connect the left channels to the L jacks and the right channels to the R jacks. If the device has a digital output, connect it to either the DIGITAL INPUT COAXIAL jack or the DIGITAL INPUT OPTICAL jack of the TX-SR600/600E depending on the type of connector on the device.

With the initial settings of the TX-SR600/600E, nothing is allocated as the digital input source for TAPE (----).

If you connect the digital audio output, be sure to make the appropriate changes at "Input Setup" → "Digital Input" (see page 53).

If the device has a digital input, connect it to the DIGITAL OUTPUT OPTICAL jack of the TX-SR600/600E for digital recording of the signal from the digital input of the TX-SR600/600E.

Note:

The output from the DIGITAL OUTPUT jack of the TX-SR600/600E is only the digital signal input to the DIGITAL INPUT jack.

Connections (TX-SR600/600E)

Connecting a DVD Player with 5.1-Channel Output

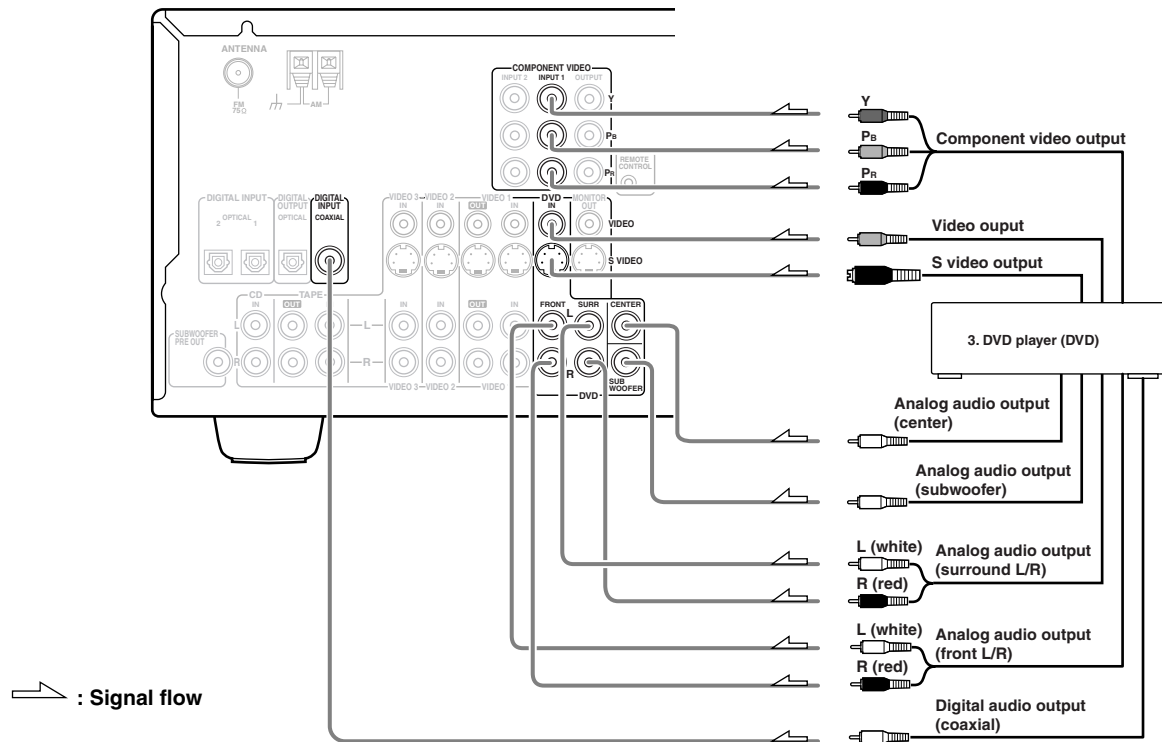

Connecting your video components

Below is an example of how you can connect your video components to the TX-SR600/600E. Refer to the diagram above for the following connection examples.

COMPONENT VIDEO INPUT/OUTPUT

For DVD players or other devices that have component video connectors, the TX-SR600/600E has two banks of component video input connectors (Y, Pb, Pr) for direct component video input. The TX-SR600/600E also has one bank of component video output connectors for direct component video output to the matrix decoder of a television, projector, or other display device. By sending the pure component video signal directly, the signal forgoes the extra processing that normally would degrade the image. The result is vastly increased image quality, with incredibly lifelike colors and crisp detail.

- The signal that comes in from COMPONENT VIDEO INPUT is only sent to COMPONENT VIDEO OUTPUT. When connecting a video player to the COMPONENT VIDEO INPUT jacks, be sure to connect your television to the COMPONENT VIDEO OUTPUT jacks.

VIDEO IN/OUT

These are the video inputs and outputs. On the rear panel, there are four video inputs and one video output and each one includes both composite video and S video configurations.

Connect VCRs, VTRs, LD players, DVD players, and other video components to the video inputs. Connect VCRs, VTRs, and other recording components to the video outputs to make video recordings.

- When connecting a VCR or other video component, make sure you connect its audio and video leads to the same bank (e.g., both to VIDEO 3).
- The VIDEO 4 inputs are located on the front panel.

The flow of the video signals is as follows:

The signal that comes in from a VIDEO IN jack is sent to the VIDEO OUT jack. The signal that comes in from a S VIDEO IN jack is sent to the S VIDEO OUT jack. It is not necessary to make both video and S video connections.

Notes:

- If your video output device (e.g., television or projector) is connected only to the MONITOR OUT VIDEO jack, MONITOR OUT S VIDEO jack, or both, and the video signal from the source component is input through the component video connectors, no picture will appear. Video sources input from the component video connectors can only be output from the component video connectors.
- For more information about the DIGITAL INPUT/OUTPUT jacks, see page 24.

Connections (TX-SR600/600E)

Connecting a DVD Player with 2-Channel (L/R) Audio Output

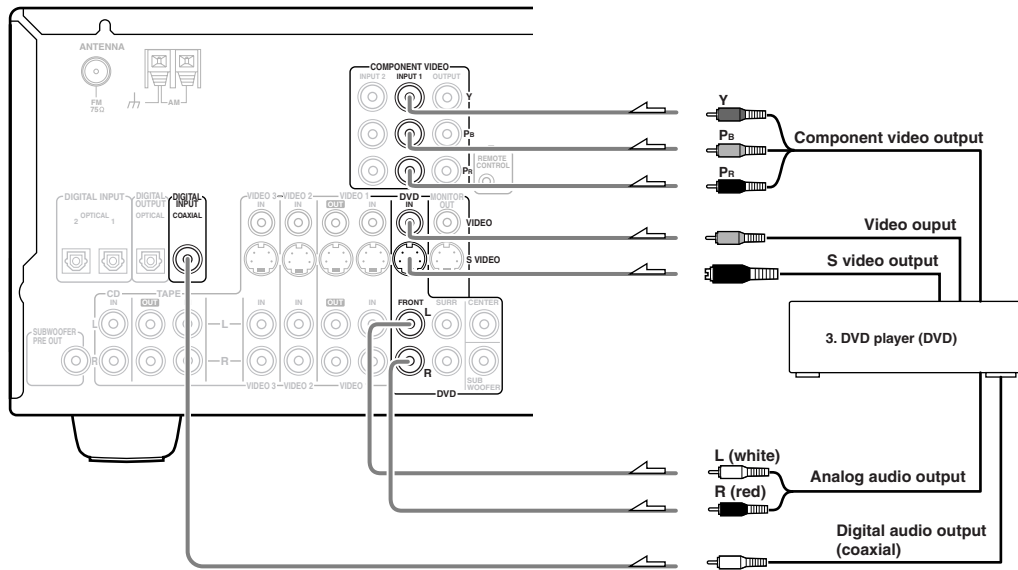

 : Signal flow

3. Connecting a DVD player (DVD)

Using an RCA video cable, connect the video output jack (composite) of the DVD player to the DVD VIDEO IN jack of the TX-SR600/600E. Or if the DVD player has an S video output jack, connect it to the DVD S VIDEO IN jack with an S video cable. Or if the device has component video outputs, connect them to the COMPONENT VIDEO INPUT 1 or 2 jacks on the TX-SR600/600E.

With the initial settings of the TX-SR600/600E, the DVD input source is set for the COMPONENT VIDEO INPUT 1 jacks.

If you connect the DVD player to the COMPONENT VIDEO INPUT 2 jacks, this must be changed at “Input Setup” → “Component Video” (see page 54).

Using an RCA audio connection cable, connect the audio output jacks of the DVD player to the DVD FRONT L/R jacks of the TX-SR600/600E. Make sure that you properly connect the left channel to the L jack and the right channel to the R jack.

If the device has a 5.1-channel output, connect the DVD FRONT L/R, SURR L/R, CENTER, and SUBWOOFER (5.1-channel input) jacks of the TX-SR600/600E to the 5.1-channel output jacks of the DVD player. Make sure that you properly connect the left channels to the L jacks and the right channels to the R jacks.

If the device has a digital output, connect it to either the DIGITAL INPUT COAXIAL jack or the DIGITAL INPUT OPTICAL jack of the TX-SR600/600E depending on the type of connector on the DVD player.

With the initial settings of the TX-SR600/600E, the DVD input source is set for digital input at the COAXIAL jack (COAX).

If the digital connection is made at a different jack, this must be changed at “Input Setup” → “Digital Input” (see page 53).

Note:

If the DVD player has both 5.1-channel audio outputs and 2-channel audio outputs, and you want to connect the DVD player only using the FRONT L/R jacks on the TX-SR600/600E, use the 2-channel audio output jacks on the DVD player.

Connections (TX-SR600/600E)

 : Signal flow

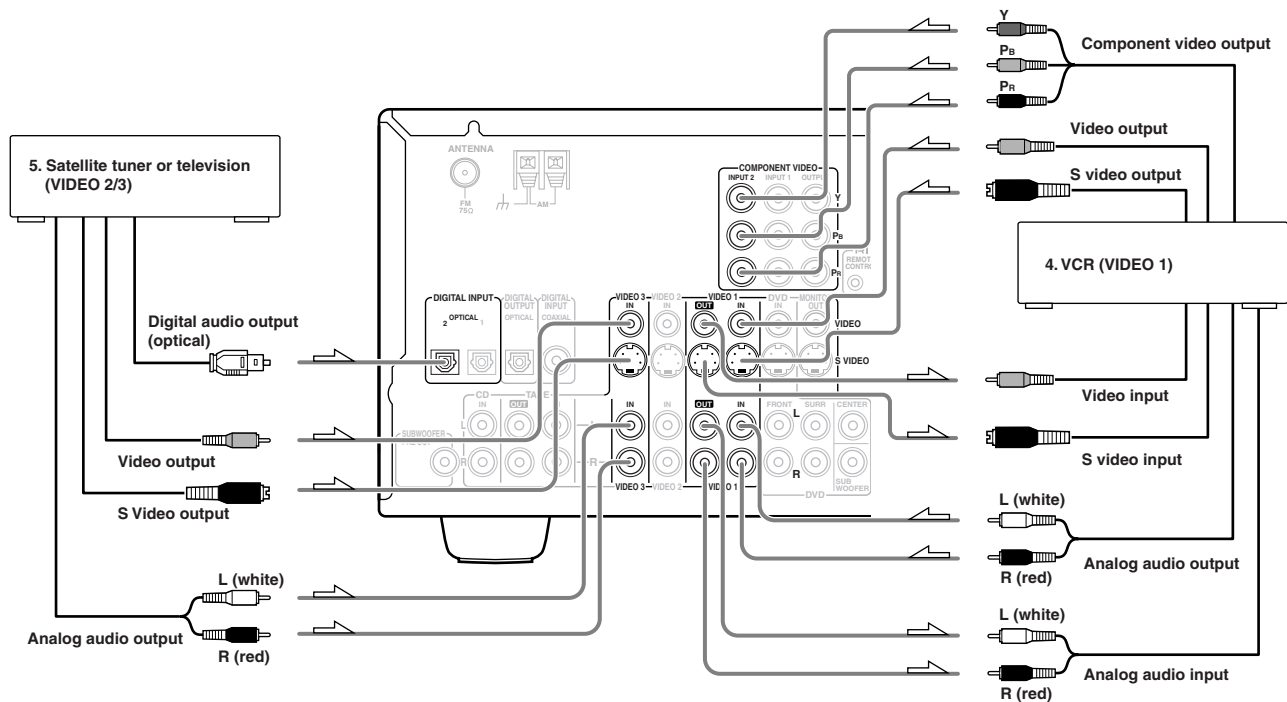

4. Connecting a video cassette recorder (VIDEO 1)

Using RCA video cables, connect the video output jack (composite) of the video cassette recorder to the VIDEO 1 VIDEO IN jack of the TX-SR600/600E and connect the video input jack of the video cassette recorder to the VIDEO 1 VIDEO OUT jack of the TX-SR600/600E. Or if the video cassette recorder has S video input and output jacks, using S video cables, connect the S video output jack of the video cassette recorder to the VIDEO 1 S VIDEO IN jack of the TX-SR600/600E and connect the video input jack of the video cassette recorder to the VIDEO 1 S VIDEO OUT jack of the TX-SR600/600E. Or if the video cassette recorder has component video outputs, connect them to the COMPONENT VIDEO INPUT 1 or 2 jacks on the TX-SR600/600E.

With the initial settings of the TX-SR600/600E, the VIDEO 1 input source is set for the COMPONENT VIDEO INPUT 2 jacks.

If you connect the video cassette recorder to the COMPONENT VIDEO INPUT 1 jacks, this must be changed at “Input Setup” → “Component Video” (see page 54).

Using RCA audio cables, connect the audio output jacks of the video cassette recorder to the VIDEO 1 IN audio jacks of the TX-SR600/600E and connect the audio input jacks of the video cassette recorder to the VIDEO 1 OUT audio jacks of the TX-SR600/600E. Make sure that you properly connect the left channels to the L jacks and the right channels to the R jacks.

With the initial settings of the TX-SR600/600E, nothing is allocated as the digital input source for VIDEO 1 (----).

If you connect the digital audio output, be sure to make the appropriate changes at “Input Setup” → “Digital Input” (see page 53).

5. Connecting a satellite tuner, television, or settop box (VIDEO 2 or 3)

Using an RCA video cable, connect the video output jack (composite) of the device to the VIDEO 2 (or 3) VIDEO IN jack of the TX-SR600/600E. Or if the device has an S video output jack, connect it to the VIDEO 2 (or 3) S VIDEO IN jack of the TX-SR600/600E using an S video cable. Or if the device has component video outputs, connect them to the COMPONENT VIDEO INPUT 1 or 2 jacks on the TX-SR600/600E.

With the initial settings of the TX-SR600/600E, the VIDEO 2 and 3 input sources are set for the COMPONENT VIDEO INPUT 2 jacks.

If you connect the device to the COMPONENT VIDEO INPUT 1 jacks, this must be changed at “Input Setup” → “Component Video” (see page 54).

Using an RCA audio cable, connect the audio output jack of the device to the VIDEO 2 (or 3) IN audio jacks of the TX-SR600/600E. Make sure that you properly connect the left channel to the L jack and the right channel to the R jack.

If the device has a digital output, connect it to either the DIGITAL INPUT COAXIAL jack or the DIGITAL INPUT OPTICAL jack of the TX-SR600/600E depending on the type of connector on the device.

With the initial settings of the TX-SR600/600E, the VIDEO 3 input source is set for digital input at the OPTICAL 2 jack (OPT 2).

If the digital connection is made at a different jack, this must be changed at Input Setup → Digital Input (see page 53).

With the initial settings of the TX-SR600/600E, nothing is allocated as the digital input source for VIDEO 2 (----).

If you connect the digital audio output, be sure to make the appropriate changes at “Input Setup” → “Digital Input” (see page 53).

Connections (TX-SR600/600E)

 : Signal flow

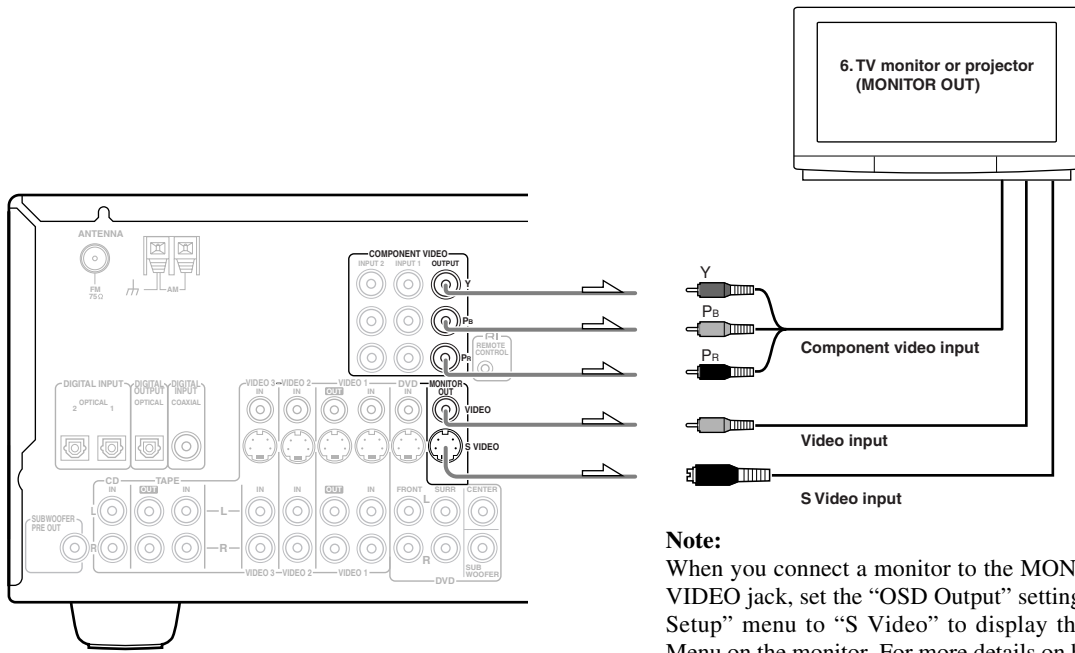

Note:
When you connect a monitor to the MONITOR OUT S VIDEO jack, set the “OSD Output” setting of the “OSD Setup” menu to “S Video” to display the OSD Setup Menu on the monitor. For more details on how to change the setting, see “When the menu is not displayed on the monitor” on page 36.

6. Connecting a television monitor or projector (MONITOR OUT)

Using an RCA video cable, connect the video input jack (composite) of the device to the MONITOR OUT VIDEO jack of the TX-SR600/600E. Or if the device has an S video input jack, connect it to the MONITOR OUT S VIDEO jack of the TX-SR600/600E using an S video cable. Or if the device has component video inputs, connect them to the bank of COMPONENT VIDEO OUTPUT jacks on the TX-SR600/600E.

Note:
Note that the Setup Menu will only be displayed on the monitor connected to MONITOR OUT and not those connected to the COMPONENT VIDEO OUTPUT jacks.

7. Connecting video camera, etc. (VIDEO 4 INPUT)

Using an RCA video cable, connect the video output jack (composite) of the device to the VIDEO 4 VIDEO jack of the TX-SR600/600E. Or if the device has an S video output jack, connect it to the VIDEO 4 S VIDEO jack of the TX-SR600/600E using an S video cable.

Using an RCA audio cable, connect the audio output jack of the device to the VIDEO 4 AUDIO jacks of the TX-SR600/600E. Make sure that you properly connect the left channel to the L jack and the right channel to the R jack.

If the device has an optical digital output, connect it to the VIDEO 4 DIGITAL jack of the TX-SR600/600E.

The VIDEO 4 digital input is fixed to the OPTICAL input on the front panel.

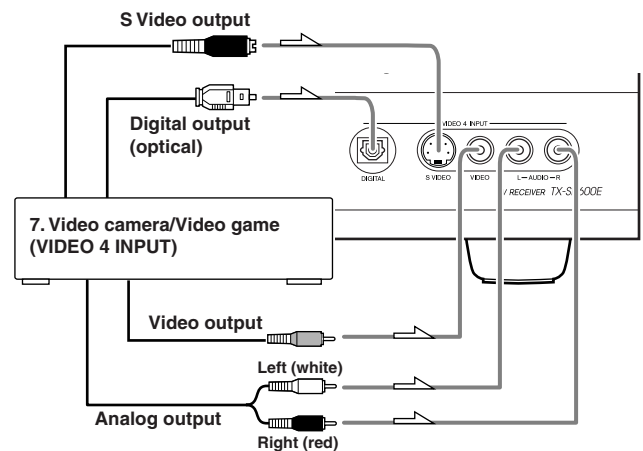

Connections (TX-SR700/700E/600/600E)

AC OUTLETS

The TX-SR700/700E/600/600E is equipped with AC mains outlets for connecting the power cords from other devices so that their power is supplied through the TX-SR700/700E/600/600E. By doing this, you can leave the connected device turned on and have the STANDBY/ON button on the TX-SR700/700E/600/600E turn on and off the device together with the TX-SR700/700E/600/600E.

The shape, number, and total capacity of the AC outlets may differ depending on the area of purchase.

Caution:

Make sure that the total capacity of the components connected to the TX-SR700/700E/600/600E does not exceed the capacity that is printed on the rear panel (e.g., TOTAL 120W).

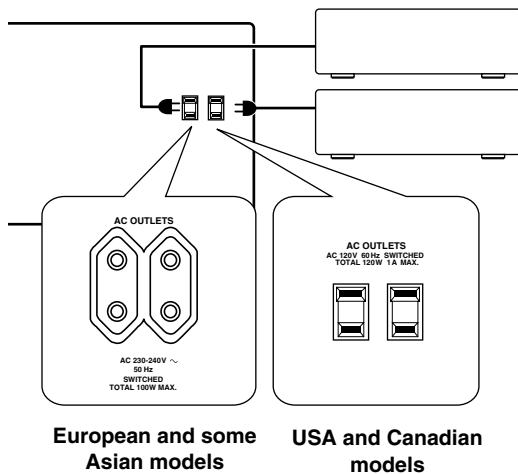

Caution:

If an MD recorder is connected to the TAPE jack on the TX-SR700/700E/600/600E, switch the Input Selector from TAPE to MD (see page 46).

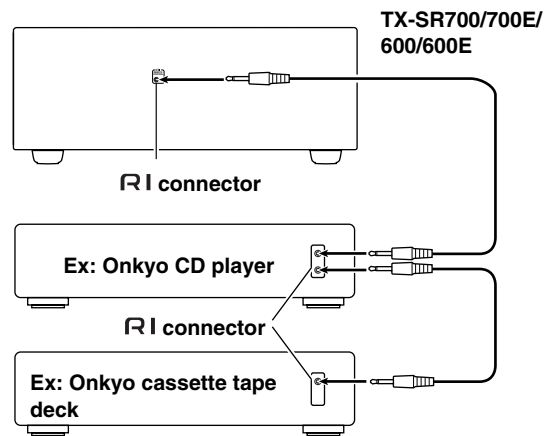

To connect components using the **RI** terminal, simply connect a remote control cable from this **RI** terminal to the **RI** terminal of the other component. An **RI** remote control cable with a 1/8-inch (3.5-mm) miniature two-conductor plug comes with every cassette tape deck, compact disc player, MD recorder, and DVD player that has an **RI** terminal.

- When performing operations with **RI**-connected components using the **RI** system, do not use the remote zone (Zone 2) (TX-SR700/700E only).
- For remote control operation, the audio connection cables must also be connected.
- If a component has two **RI** terminals, you can use either one to connect to the TX-SR700/700E/600/600E. The other one can be used to daisy chain with another component.
- With Onkyo DVD players, you can enter the pre-program code so that you can operate the DVD player directly with the remote controller without connecting the **RI** terminals (see page 67).

RI REMOTE CONTROL

The **RI** terminal on the TX-SR700/700E/600/600E is for connecting other Onkyo components equipped with the same **RI** terminal. When a component is connected to the **RI** terminal, it can be operated by the remote controller supplied with the TX-SR700/700E/600/600E. In addition, when you connect a component to the **RI** terminal, you can also perform the system operations given below.

Power on/ready function

When the TX-SR700/700E/600/600E is in the standby state, if an **RI**-connected component is turned on, the TX-SR700/700E/600/600E also turns on and the input source selected at the TX-SR700/700E/600/600E automatically switches to that component.

Be aware that this function will not work if the power cord for the **RI**-connected component is connected to the AC OUTLET on the TX-SR700/700E/600/600E, or if the TX-SR700/700E/600/600E has already been turned on.

Direct change function

When the play button is pressed at an **RI**-connected component, the input source selected at the TX-SR700/700E/600/600E automatically changes to that component.

Power off function

When the TX-SR700/700E/600/600E is placed in the standby state, all **RI**-connected components are also automatically put into the standby state.

Also, if you press the ON button on the TX-SR700/700E/600/600E remote controller while the TX-SR700/700E/600/600E is turned on, all **RI**-connected components (DVD players, CD players, MD recorders, tuners, etc.) are also turned on.

Connecting speakers

Before connecting the speakers, it is very important to place them properly for the optimum sound space for your listening pleasure. Be sure to refer to the instruction manuals that came with the speakers during placement and connection. Furthermore, be aware that for surround playback, the configuration and placement of your speakers are both very important.

Standard speaker setup for surround sound

- **Front right and left speakers**
- **Center speaker**
Produces a rich sound image by serving as a sound source for the front right and left speakers and enhancing the sonic movement.
- **Surround right and left speakers**
Adds three-dimensional sonic movement and produces environmental sound associated with the background and effect sound for each scene.
- **Surround back speaker**
Required for enjoying Dolby Digital EX or DTS-ES audio. Improves the quality of sound effects and the realistic acoustics.
- **Subwoofer**
Produces powerful and heavy bass.

Minimum speaker configuration for surround sound playback

- **Front right and left speakers**
- **Surround right and left speakers**

The sound recorded for the center speaker and the subwoofer will be properly distributed to the front right and left speakers for optimized surround playback.

Speaker placement

Ideal speaker placement varies depending on the size of your room and the wall coverings. Here, only typical examples of speaker placement and recommendations are shown.

Important points regarding speaker placement

Front left and right speakers and center speaker

- Place these three speakers all at the same height.
- Place each speaker so that it is aimed at the location of the listener's ears when at the listening position.
- Place front left and right speakers at the same distance from the listening position.

Surround left and right speakers

Place these speakers so that their height is 3 feet (1 meter) higher than that of the listener's ears.

Surround back speaker

Place these speakers so that their height is 3 feet (1 meter) higher than that of the listener's ears.

Subwoofer

A subwoofer is recommended for the highest bass effect.

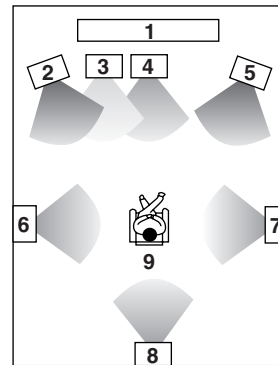

- | | |
|-----------------------|--------------------------|
| 1 TV or screen | 6 Surround left speaker |
| 2 Front left speaker | 7 Surround right speaker |
| 3 Subwoofer | 8 Surround back speaker |
| 4 Center speaker | 9 Listening position |
| 5 Front right speaker | |

Using the speaker labels

The positive speaker terminals on the TX-SR700/700E/600/600E are color coded for easy identification. Attach the supplied speaker labels to the speaker cables, and then match the colors on the speaker cables to the corresponding terminals.

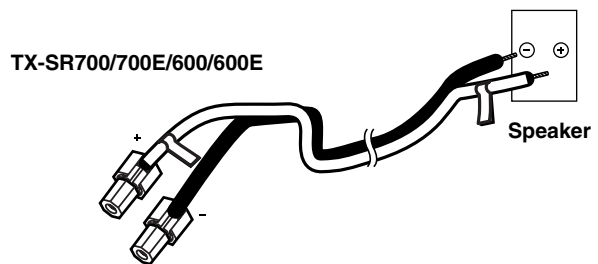

The speaker channels are colored as follows:

- Front left speaker (+): White
- Front right speaker (+): Red
- Center speaker (+): Green
- Surround left speaker (+): Blue
- Surround right speaker (+): Grey
- Zone 2 left speaker (+): White (TX-SR700/700E only)
- Zone 2 right speaker (+): Red (TX-SR700/700E only)

Connecting speakers

Connecting speakers

After determining the layout of your speaker system, it is now necessary to connect the speakers correctly to your TX-SR700/700E/600/600E.

Caution:

- Be sure to connect the positive (+) and negative (-) cables for the speakers properly. If they are mixed up, the left and right signals will be reversed and the audio will sound unnatural.
- Do not connect more than one speaker cable to one speaker terminal. Doing so may damage the TX-SR700/700E/600/600E.
- When you listen to surround audio or select Multichannel, be sure to turn on SPEAKERS A.
- **Connect only speakers with an impedance between 6 and 16 Ω to the TX-SR700/700E/600/600E. Connecting speakers with an impedance lower than 6 Ω may damage the amplifier.**
- Even if you are using only one speaker or listening to monaural (mono) sound, never connect a single speaker in parallel to both the right and left-channel terminals.

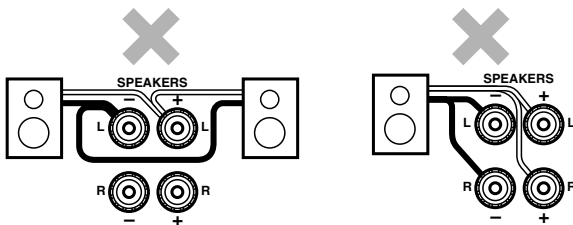

- To prevent damage to circuitry, never short-circuit the positive (+) and negative (-) speaker wires.

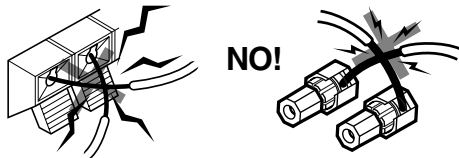

Connecting the speaker cable

1. Strip away approx. 5/8 inch (15 mm) of the wire insulation.

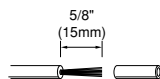

2. Twist the wire ends tightly together.

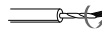

3. Unscrew the speaker terminal cap.



4. Insert the exposed wire end.

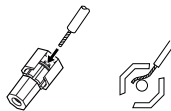

5. Screw down the speaker terminal cap.



SPEAKER B (TX-SR600/600E only)

1. Strip away approx. 3/8 inch (10 mm) of the wire insulation.

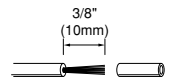

2. Twist the wire ends tightly together.

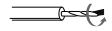

3. Press the lever to open the terminal.

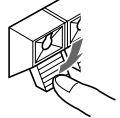

4. Insert the exposed wire end.

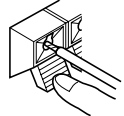

5. Release the lever to close the terminal. Leave some of the exposed wire showing outside the terminal.

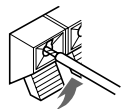

Connecting a subwoofer

Use the SUBWOOFER PRE OUT jack to connect a subwoofer with a built-in power amplifier. If your subwoofer does not have a built-in amplifier, connect an amplifier to the SUBWOOFER PRE OUT jack and the subwoofer to the amplifier.

Connecting to the SPEAKERS B terminals (TX-SR600/600E only)

If you require an additional set of front speakers (left and right), such as for use in another room, connect them to the FRONT SPEAKERS B inputs.

Connecting speakers

TX-SR700/700E

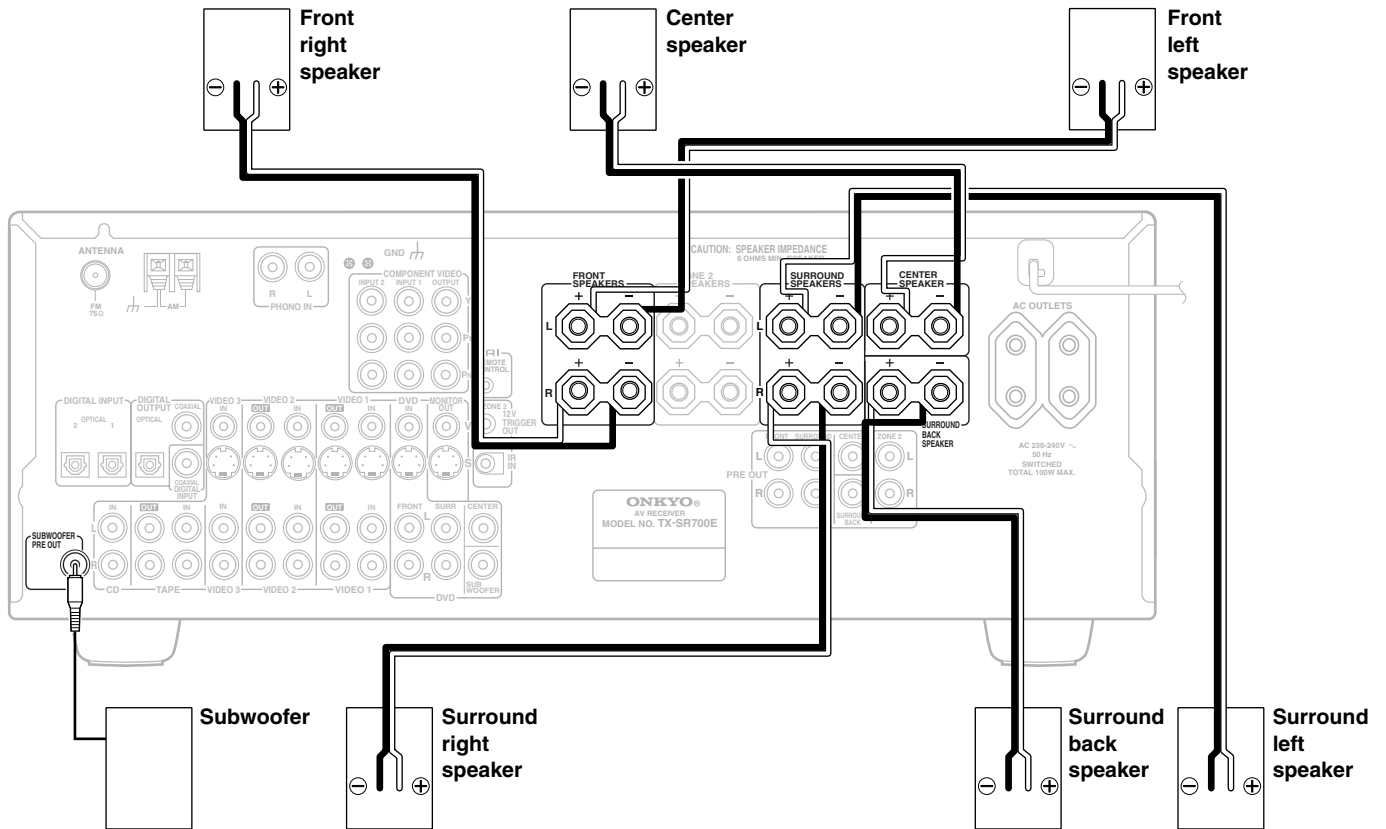

TX-SR600/600E

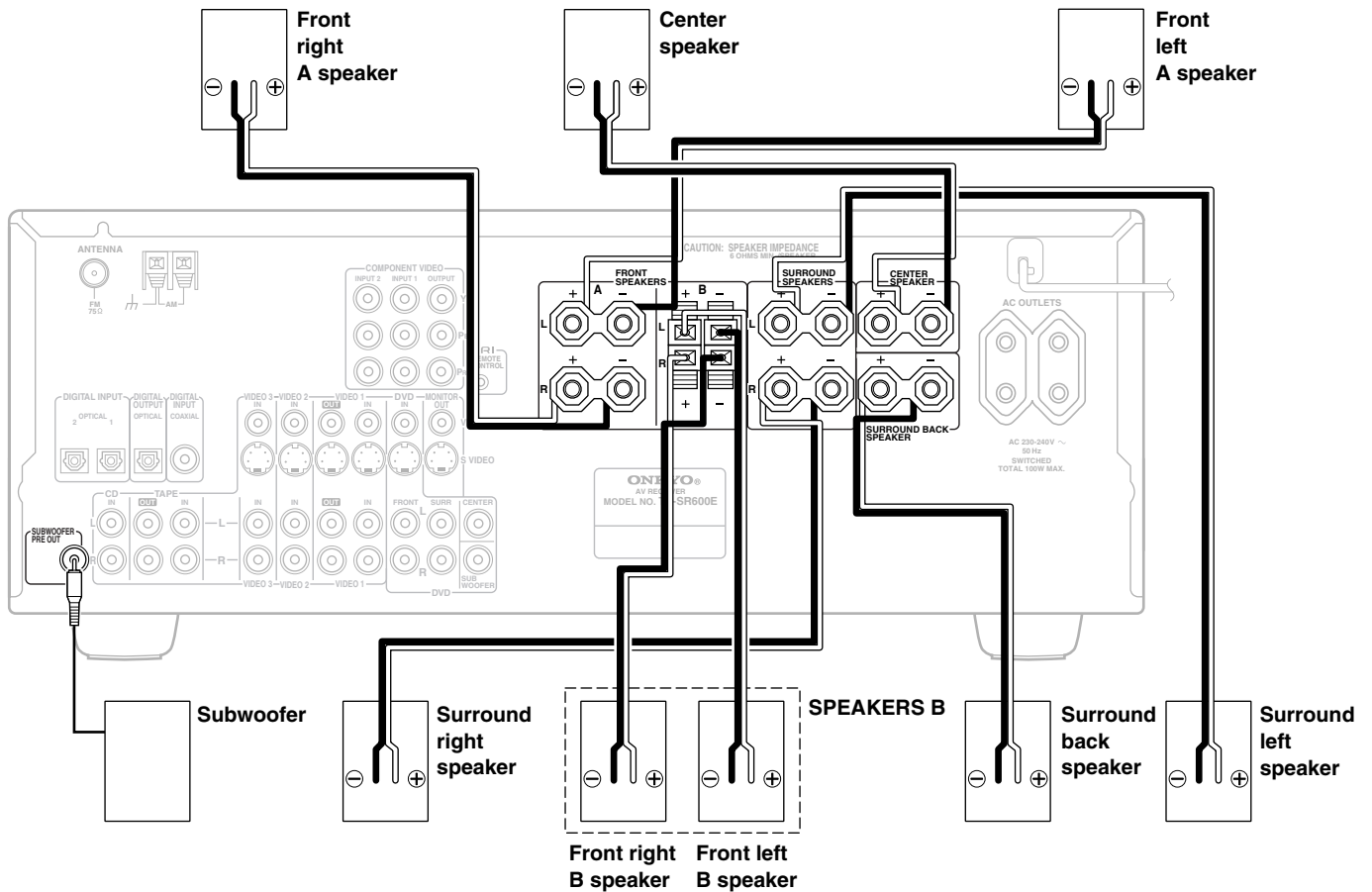

Connecting the power

Diagram for TX-SR700E

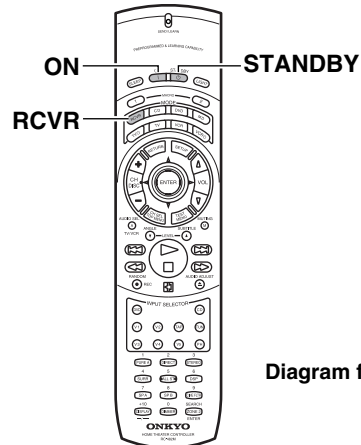
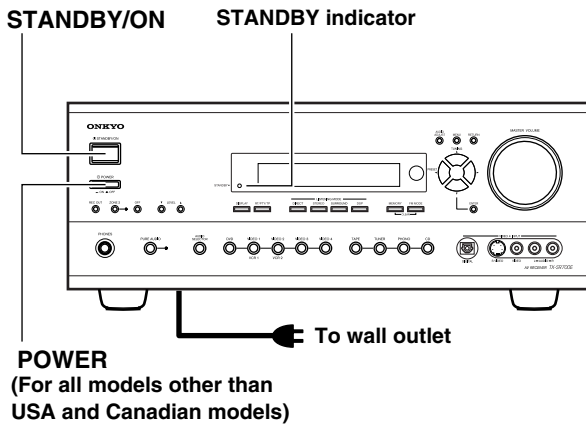

Diagram for RC-482M

- Before you plug in the TX-SR700/700E/600/600E, confirm that all connections have been made properly.
- Turning on the power may cause a momentary power surge, which might interfere with other electrical equipment on the same circuit, such as computers. If this happens, use a wall outlet on a different circuit.

(All models other than USA and Canadian models)

- The TX-SR700/700E/600/600E is shipped with the main power (POWER) switch in the on position (ON). When the power cord is plugged in for the first time, the TX-SR700/700E/600/600E will automatically enter the standby state and the STANDBY indicator will light (same condition after step 2 below).

Turning on the power

1. Plug the power cord into an AC wall outlet.

(USA and Canadian models)

The STANDBY indicator will light up.



(All models other than USA and Canadian models)

Press the POWER switch to set the TX-SR700/700E/600/600E to standby state.

The STANDBY indicator will light up.



2. Press the STANDBY/ON button to turn on the TX-SR700/700E/600/600E.

The display will light up and the STANDBY indicator will turn off.

If you press the STANDBY/ON button again, the receiver returns to standby state.



Turn off



Turning on the power from the remote controller

Before you can use the remote controller, you must perform step 1 above and place the TX-SR700/700E/600/600E in the standby state.

1. Press the RCVR MODE button.

The RCVR MODE button lights green.

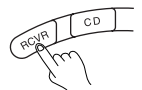

2. Press the ON button to turn on the TX-SR700/700E/600/600E (take it out of the standby state).

To return the TX-SR700/700E/600/600E to the standby state, press the STANDBY button.

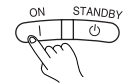

Memory preservation (Other than USA and Canadian models)

The TX-SR700/700E/600/600E does not require memory preservation batteries. A built-in memory backup system preserves the contents of memory (e.g., speaker settings and surround settings) during power failures and even when the power is turned off with the POWER switch. The backup system is charged when the POWER switch is turned on.

The length of time that the memory will be preserved will vary depending on the ambient climate. On the average, memory contents are protected over a period of a few weeks after the last time the unit has been turned off. This period may be shorter when the unit is exposed to a highly humid climate.

Memory preservation (USA and Canadian models)

The TX-SR700/600 does not require memory preservation batteries. A built-in memory backup system preserves the contents of memory (e.g., speaker settings and surround settings) during power failures and even when the unit is unplugged. The unit must be plugged in order to change the back-up system.

The length of time that the memory will be preserved will vary depending on the ambient climate. On the average, memory contents are protected over a period of a few weeks after the last time the unit has been unplugged. This period may be shorter when the unit is exposed to a highly humid climate.

Connecting antennas

To use the tuner of the TX-SR700/700E/600/600E, it is necessary to prepare the supplied FM and AM antennas.

- Adjustment and placement of the FM and AM antennas for better reception must be done while listening to a station broadcast.
- If better reception cannot be obtained, then placement of an outside antenna is recommended.

Assembling the AM loop antenna

Assemble the loop antenna as shown in the illustration.

- Refer to “Connecting the AM loop antenna” below for details on how to connect the loop antenna.

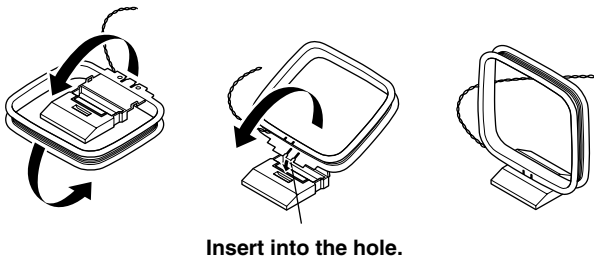

Connecting the AM antenna cable

1. Press down the lever at the antenna terminal.
2. Insert the wire into the terminal hole.
3. Release the lever.

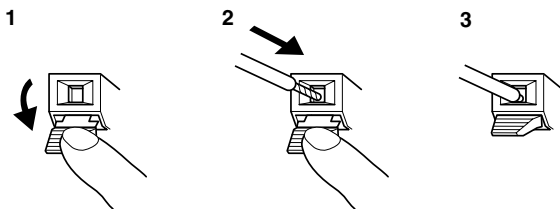

Connecting the included antennas

Connecting the FM indoor antenna:

The FM indoor antenna is for indoor use only. During use, extend the antenna and adjust its orientation until the clearest signal is received. Fix it with push pins or similar items in the position that will cause the least amount of distortion.

If the reception is not very clear with the attached FM indoor antenna, the use of an outdoor antenna is recommended.

Connecting the AM loop antenna:

The AM loop antenna is for indoor use only. Set it in the direction and position where you receive the clearest sound. Put it as far away as possible from the TX-SR700/700E/600/600E, televisions, speaker cables, and power cords.

If the reception is not very clear with the attached AM indoor antenna, the use of an outdoor antenna is recommended.

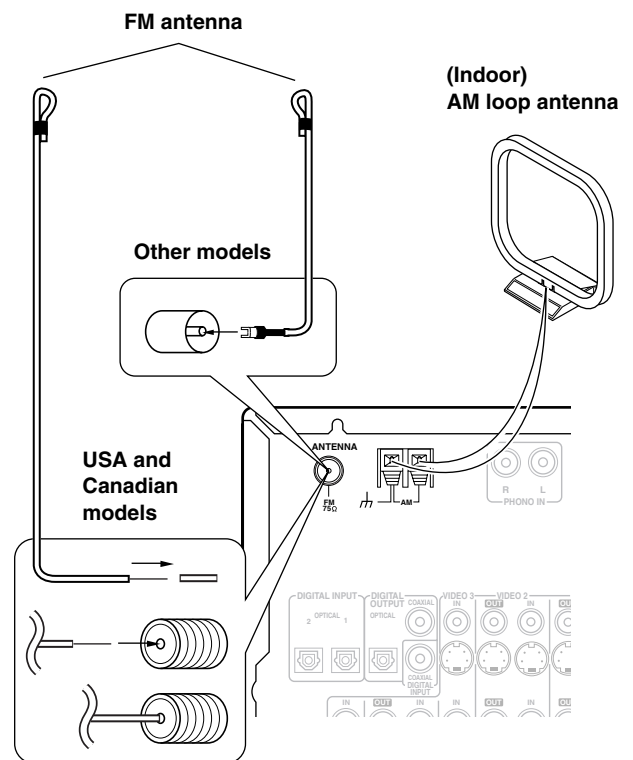

Strip away the insulation from the end of the cable, and fully insert the stripped end of the cable.

Hint:

Either of the split ends of the AM antenna can be connected to either terminal. Unlike speaker cabling, there is no polarity for AM broadcast signals.

Connecting antennas

Connecting an FM outdoor antenna

Make sure to follow the general rules given below:

- Keep the antenna away from noise sources (neon signs, busy roads, etc.).
- It is dangerous to put the antenna close to power lines. Keep it well away from power lines, transformers, etc.
- To avoid the risk of lightning and electrical shock, grounding is necessary. Follow item 14 of the “Important Safeguards” on page 2 when you install the outdoor antenna.

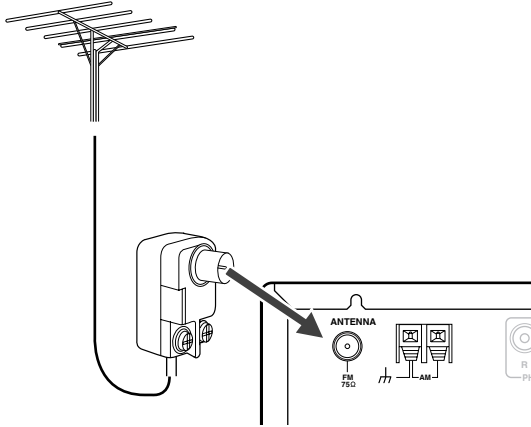

Connecting an AM outdoor antenna

If reception is poor with the indoor AM antenna, stretch out the outdoor antenna (16 feet (5 meters) or more) above a window or outside.

- Keep the indoor AM loop antenna connected. Do not remove it.
- To avoid the risk of lightning and electrical shock, grounding is necessary. Follow item 14 of the “Important Safeguards” on page 2 when you install the outdoor antenna.

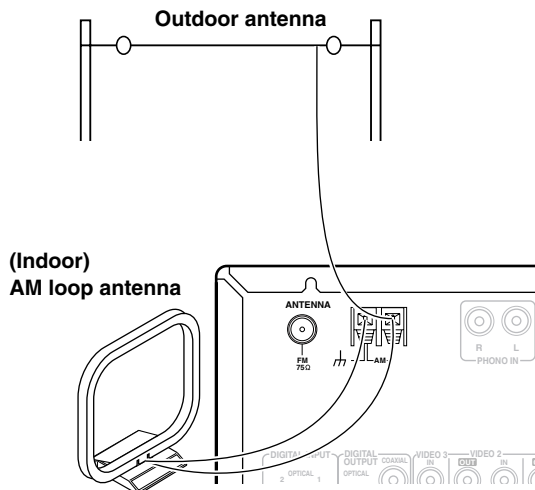

Note: If you are using the TX-SR700/700E/600/600E worldwide model in a region where AM frequencies are delineated by 10-kHz steps, be sure to set the “AM Frequency Step” Setup setting accordingly (see page 56).

Directional linkage

Do not use the same antenna for both FM and TV (or VCR) reception since the FM and TV (or VCR) signals can interfere with each other. If you must use a common FM/TV (or VCR) antenna, use a directional linkage type splitter.

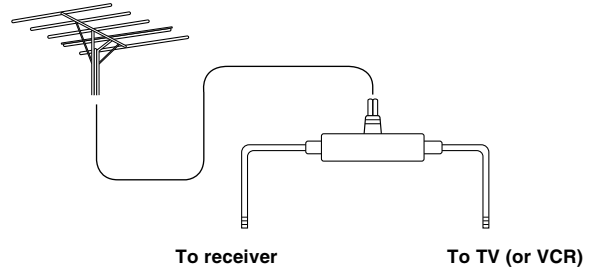

Connecting the antenna cable to the 75/300 Ω antenna adapter (For all models other than USA & Canadian models and European models)

Connecting the 300 Ω ribbon wire: Loosen the screws on the adapter and wrap the wires of the ribbon wire around these screws. Then tighten the screws down with a screwdriver.

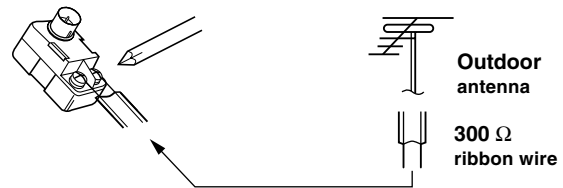

Connecting the coaxial cable:

1. With your fingernail, or a small screwdriver, press the stoppers of the 75/300 Ω antenna adapter outward and remove the cover.
2. Remove the transformer wire A from slit B and insert it into slit C.
3. Prepare the coaxial cable as shown in the diagram.
4. Connect the 75/300 Ω antenna adapter to the coaxial cable.
 1. Insert the end of the cable.
 2. Clamp it in place with pliers.
5. Reinstall the cover.

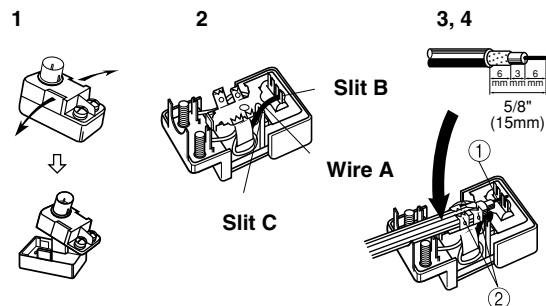

Configuring the speakers

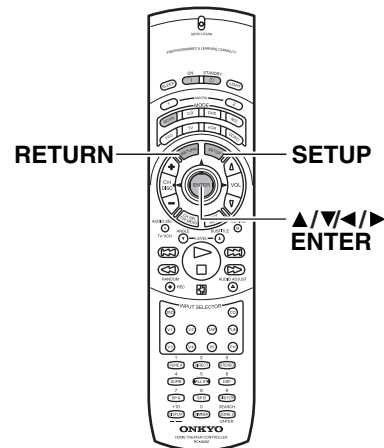
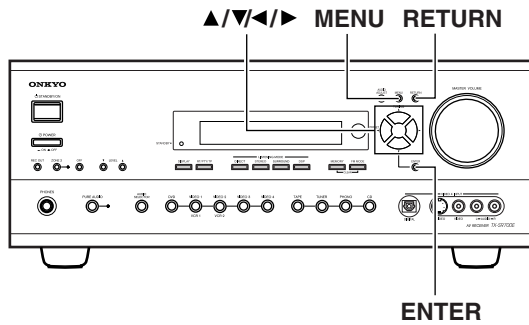

To create the optimum sound space for both visual and audio pleasure, it is necessary to set the size of the speakers and their distance from your normal listening position. Once made, you will not need to change these settings unless you change the speaker configuration or positions. Once you have connected the speakers, complete the following settings using the OSD Setup menu* before using the speakers.

*OSD Setup Menu

The OSD (On Screen Display) Setup Menu is displayed on the TV or projector monitor connected to the TX-SR700/700E/600/600E. It is used to configure the various settings of the TX-SR700/700E/600/600E for optimum performance.

Speaker Configuration

1. Display the main menu.
2. Use the ▲ and ▼ cursor buttons to select “1. Speaker Config.”

TX-SR700/700E/600/600E

Remote controller

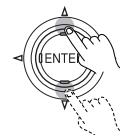
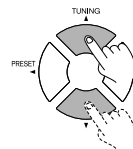

Displaying the Main Menu

1. Display the main menu.

Press the MENU button on the front panel or SETUP button on the remote controller to display the main menu (Menu) on the monitor and front display.

TX-SR700/700E/
600/600E

Remote
controller

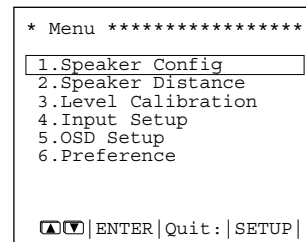
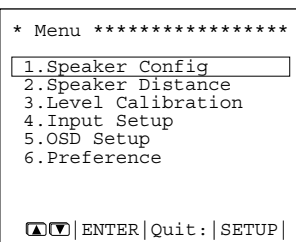

1.Sp Config

3. Press the ENTER button.

TX-SR700/700E/600/600E

Remote controller

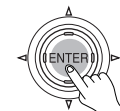

When the menu is not displayed on the monitor (TX-SR600/600E only)

The default OSD Output setting is “Video” (see page 56). When the monitor is connected to the S Video jack, change the “OSD Output” setting to “S Video.”

1. Press the MENU button on the front panel or SETUP button on the remote controller.
2. Use the ▲ and ▼ cursor buttons to select “5. OSD Setup” and then press the ENTER button.
3. Use the ▲ and ▼ cursor buttons to select “OSD Output” and then use the ◀ and ▶ cursor buttons to select “S Video.”
4. Press the ENTER button.

The speaker configuration menu appears.

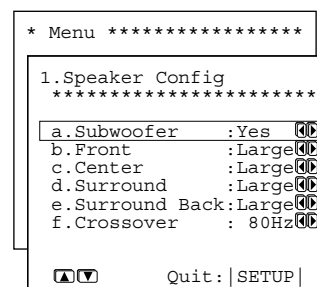

Subwoofer :Yes

Configuring the speakers

- Use the ▲ and ▼ cursor buttons to select “Subwoofer” and then use the ◀ and ▶ cursor buttons to select the subwoofer setting.

Yes: Select when a subwoofer is connected.

No: Select when a subwoofer is not connected.

TX-SR700/700E/600/600E Remote controller

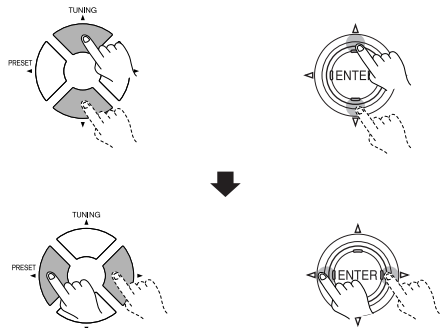

- Use the ▲ and ▼ cursor buttons to select “Front” and then use the ◀ and ▶ cursor buttons to select the front speaker setting.

Large: Select if the front speakers are large sized.

Small: Select if the front speakers are small sized.

- If “No” is selected for the Subwoofer setting, this setting is fixed to “Large.”

- Use the ▲ and ▼ cursor buttons to select “Center” and then use the ◀ and ▶ cursor buttons to select the center speaker setting.

None: Select if no center speaker is connected.

Large: Select if the center speaker is large sized.

Small: Select if the center speaker is small sized.

- If “Small” is selected for the Front setting, “Large” cannot be selected for this setting.

- Use the ▲ and ▼ cursor buttons to select “Surround” and then use the ◀ and ▶ cursor buttons to select the surround speaker setting.

None: Select if no surround left and right speakers are connected.

Large: Select if the surround left and right speakers are large sized.

Small: Select if the surround left and right speakers are small sized.

- If “Small” is selected for the Front setting, “Large” cannot be selected for this setting.

- Use the ▲ and ▼ cursor buttons to select “Surround back” and then use the ◀ and ▶ cursor buttons to select the surround back speaker setting.

None: Select if no surround back speaker is connected.

Large: Select if the surround back speaker is large sized.

Small: Select if the surround back speaker is small sized.

- If “None” is selected for the Surround setting, this setting will not appear.
- If “Small” is selected for the Surround setting, “Large” cannot be selected for this setting.

- Use the ▲ and ▼ cursor buttons to select “Crossover” and then use the ◀ and ▶ cursor buttons to select the crossover frequency mode setting.

Adjustable Crossover (80/100/120 Hz) for Bass Management

This setting allows you to set the crossover frequency for your speaker system. This setting is valid when “Subwoofer” is set to “Yes,” or for speakers that are set to “Small,” at the “Speaker Config” menu. The crossover frequency is the minimum frequency delivered to a speaker and can be set to 80 Hz, 100 Hz, or 120 Hz. Frequencies below this are cut from speakers set to “Small” and sent to the subwoofer (or to speakers set to “Large”).

Press the RETURN button to return to the main menu.

Press the MENU button on the front panel or SETUP button on the remote controller to exit the Setup menu.

Configuring the speakers

Setting the speaker distance from your normal listening position

Each speaker can be set between 1 and 30 feet (0.3 and 9 meters) in 1-foot (0.3 meter) increments. Select the setting closest to the actual distance from the speaker to your normal listening position.

Note:

Speakers that you selected “No” or “None” for in the “Speaker Config” menu will not appear in this menu.

- Use the ▲ and ▼ cursor buttons to select “2. Speaker Distance” on the main menu and then press the ENTER button.

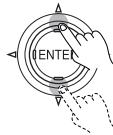

The “Speaker Distance” menu appears.

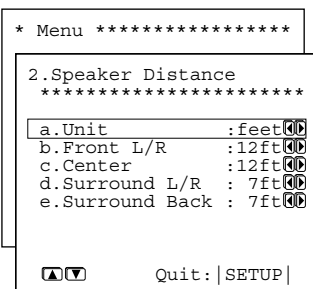
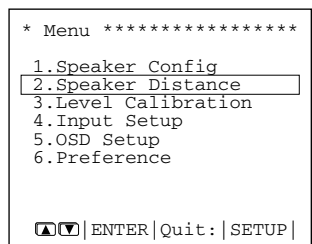

2. Sp Distance

Unit : feet

- Use the ▲ and ▼ cursor buttons to select “Unit” and then use the ◀ and ▶ cursor buttons to select the desired unit of measure.

feet: Select if you will enter the distances in feet.

meters: Select if you will enter the distances in meters.

- Use the ▲ and ▼ cursor buttons to select “Front L/R” and then use the ◀ and ▶ cursor buttons to set the distance from the front speakers to your normal listening position.
- Use the ▲ and ▼ cursor buttons to select “Center” and then use the ◀ and ▶ cursor buttons to set the distance from the center speakers to your normal listening position.

Note:

You can only set a distance less than that set for the front speakers and within 5 feet (1.5 meters) of the front speaker setting. For example, if 30 feet (9 meters) is set for the front speakers, then the center speaker distance can only be set between 25 and 30 feet (7.5 and 9 meters).

- Use the ▲ and ▼ cursor buttons to select “Surround L/R” and then use the ◀ and ▶ cursor buttons to set the distance from the left surround and right surround speakers to your normal listening position.

Note:

You can only set a distance less than that set for the front speakers and within 15 feet (4.5 meters) of the front speaker setting. For example, if 30 feet (9 meters) is set for the front speakers, then the surround speaker distance can only be set between 15 and 30 feet (4.5 and 9 meters).

- Use the ▲ and ▼ cursor buttons to select “Surround Back” and then use the ◀ and ▶ cursor buttons to set the distance from the surround back speakers to your normal listening position.

Press the RETURN button to return to the main menu.

Press the MENU button on the front panel or SETUP button on the remote controller button to exit the Setup menu.

Calibrating the speaker levels

Use this menu to set the volume for each speaker so that each volume is heard by the listener at the same level. This is especially important for speaker layouts where the left and right speakers are at different distances or in asymmetrical positions due to room designs and configurations. These settings and the distance settings performed in the Speaker Distance menu are vital to create the proper sound space and dynamics.

Note:

The speaker level settings here are not effective for multi-channel input sources. To adjust the speaker levels for multi-channel input sources, you will need to use the CH SEL, LEVEL ▲, and LEVEL ▼ buttons on the remote controller. See page 47.

- Use the ▲ and ▼ cursor buttons to select “3. Level Calibration” on the main menu and then press the ENTER button.

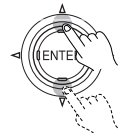

The “Level Calibration” menu appears.

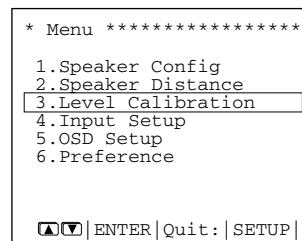

3. Level Cal

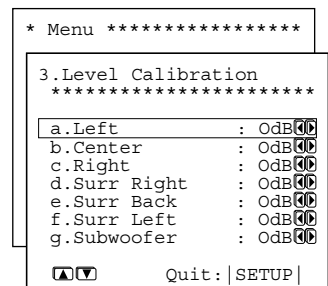

Left : 0.

Note:

Speakers that you selected “No” or “None” for in the “Speaker Config” menu will not appear.

- Use the ▲ and ▼ cursor buttons to select “Left.”

You will hear a pink noise from the front left speaker.



Configuring the speakers

- (1) Remember the volume level of this noise and then press the ▼ cursor button. The TX-SR700/700E/600/600E will now emit the pink noise from the center speaker.
- (2) Using the ◀ and ▶ cursor buttons, adjust the volume level of the noise from the center speaker so that it is at the same level as that that was emitted from the front left speaker.
- (3) Press the ▼ cursor button again. The TX-SR700/700E/600/600E will now emit the pink noise from the front right speaker.
Use the ◀ and ▶ cursor buttons to adjust the volume of the noise from the front left speaker so that it is the same level as that that was emitted from the center speaker.
- (4) Use the ▼ cursor button to select other speakers and adjust the volumes until all speakers are adjusted to the same level.

The pink noise level can be adjusted to anywhere between -12 and +12 decibels for all speakers in 1-decibel increments.

Press the RETURN button to return to the main menu.
Press the MENU button on the front panel or SETUP button on the remote controller to exit the Setup menu.

Using the remote controller

1. Press the TEST button.

You will hear a pink noise will be emitted from the front left speaker.



- (1) Remember the volume level of this noise and then press the CH SEL button. The TX-SR700/700E/600/600E will now emit the pink noise from the center speaker.
- (2) Using the LEVEL ▲/▼ buttons, adjust the volume level of the noise from the center speaker so that it is at the same level as that that was emitted from the front left speaker.
- (3) Press the CH SEL button again. The TX-SR700/700E/600/600E will now emit the pink noise from the front right speaker.

Use the LEVEL ▲/▼ buttons to adjust the volume of the noise from the front left speaker so that it is the same level as that that was emitted from the center speaker.

- (4) Use the CH SEL button to select other speakers and adjust the volumes until all speakers are adjusted to the same level.

The pink noise level can be adjusted to anywhere between -12 and +12 decibels for all speakers in 1-decibel increments.

2. Press the TEST button to complete the procedure.



Buttons used for navigating through the menus

You can change settings in the Setup Menu using the buttons on the front panel and on the remote controller.

The buttons on the remote controller correspond to those on the TX-SR700/700E/600/600E as shown below.

Buttons on remote controller		Buttons on TX-SR700/700E/600/600E
Displaying the Main Menu and exiting the menu		
	SETUP	MENU
Selecting a menu or menu item		
	(upper edge of ENTER button)	UP
	(lower edge of ENTER button)	DOWN
Setting the value		
	(left edge of ENTER button)	LEFT
	(right edge of ENTER button)	RIGHT
Selecting the menu		
	ENTER	ENTER
Returning to the previous screen		
	RETURN	RETURN

Listening to Radio Broadcasts

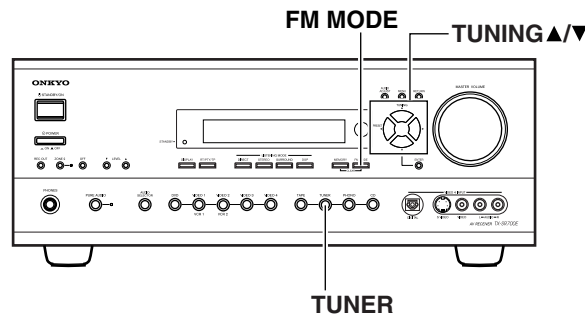

One of the features of the TX-SR700/700E/600/600E that is most frequently used is its ability to play FM and AM broadcast radio stations. The TX-SR700/700E/600/600E provides a number of listening modes perfect for listening to the radio and getting the most out of your audio system. Also, by presetting radio stations that you listen to frequently, you can select them easily by pressing the CH \leftrightarrow button on the remote controller.

Listening to a stereo radio station (FM mode)

When you tune into a radio station, ► TUNED ◀ indicator appears in the display. If you tune into an FM station in stereo, then “FM STEREO” appears. If the signal is weak, it may be impossible to tune into the station in stereo. In such a case, **press the FM MODE button** on the front panel. The AUTO indication disappears and the radio station is output in the monaural mode. To return to stereo, press the FM MODE button again. “AUTO” appears. Some inter-station noise may be heard, but the sound will not cut in and out as it would if stereo was selected.



Tuning into a radio station

1. Press the TUNER input source button.

Each time you press the TUNER button, the input source changes between AM and FM.



2. Using the TUNING ▲ and ▼ buttons on the front panel, tune into the station you desire.

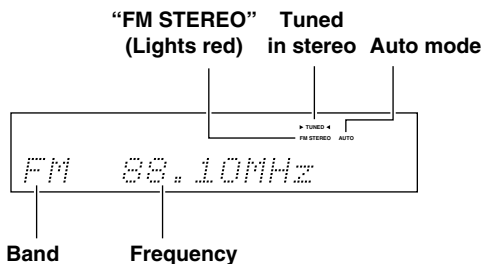
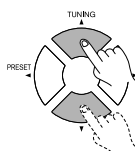

- The tuner frequency changes in 50-kHz increments for FM and 10-kHz (or 9-kHz) increments for AM.
- You can press the TUNING ▲ or ▼ button continuously for more than 0.5 seconds for an FM station in the direction of the button you pressed (FM auto tuning mode). After you release the button and a station is received in stereo, the scanning stops.
- The European model allows you to receive RDS broadcasts. See page 42 for more information regarding tuning into RDS broadcasts.

Listening to Radio Broadcasts

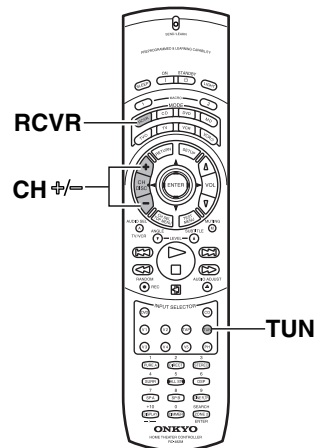
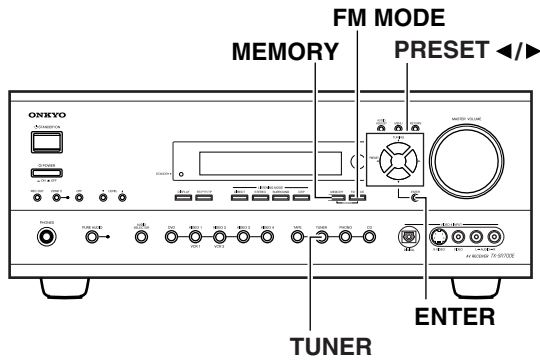

Presetting a radio station

1. Tune into the radio station you desire (see “Tuning into a radio station”).



2. Press the MEMORY button on the front panel.



The MEMORY indicator lights red.

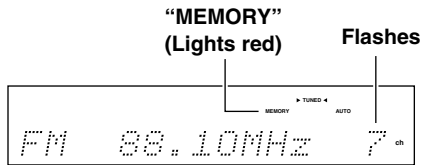

3. Using the PRESET buttons, select a preset number (from 1 to 40) to assign the station.

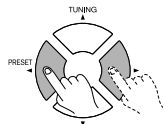

4. Press the ENTER button to finalize the procedure.



The memory indicator turns off and the assigned number lights.

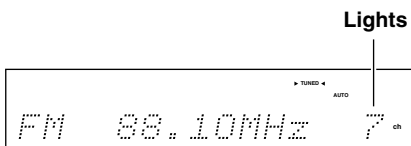

This programs the radio station as a preset radio station.

- Up to 40 stations can be stored in memory as preset radio stations.

Selecting a preset radio station

1. Press the TUNER input source button.



2. Press the PRESET buttons and select the number of the desired preset station.

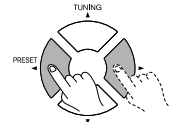

When using the remote controller:

1. Press the RCVR MODE button. The RCVR MODE button lights green.

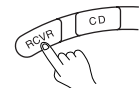

2. Press the TUN button.



3. Press the CH +/- button and select the number of the desired preset station.

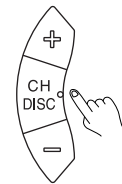

Erasing a preset radio station

This can only be performed at the TX-SR700/700E/600/600E.

1. Press the TUNER button and press the PRESET buttons to select the preset radio station that you want to erase (see above).

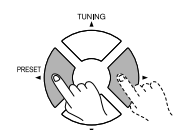
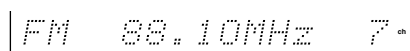

2. Press and hold the MEMORY button and then press the FM MODE button.

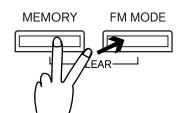

The selected preset station is erased.

Listening to RDS broadcasts (European models only)

Listening to RDS broadcasts

RDS reception is available only on the European model and only in areas where RDS broadcasts are available.

What is RDS?

RDS stands for Radio Data System and is a type of FM broadcasting. RDS was developed within the European Broadcasting Union (EBU) and is available in most European countries. Many FM broadcasting stations now transmit the RDS signals, which provide the additional information required. RDS provides you with various services so that you can choose a station that broadcasts your favorite categories of music, news, or other information.

There are three main classifications of RDS broadcasts. Though they can be tuned into by using the TUNING buttons as normal stations, RDS broadcasts allow you to scan for stations of the type and classification for which you are looking. This makes it much easier for you to find the station you want (see “Performing a PTY scan” and “Performing a TP scan” on page 43). The three main classifications are explained below.

RT: Radio Text

When an RDS station broadcasting RT information is selected, the text information received from the station is displayed.

PTY: Program Type

When an RDS station broadcasting PTY information is selected, the station type (classification) is displayed.

TP: Traffic Program

When an RDS station broadcasting TP information is selected, traffic information will be broadcasted periodically.

Notes:

- In some cases, the characters displayed on the display of the TX-SR700E/600E may not be exactly the same as the ones broadcast by the radio station. Also, unusual characters may appear on the display if the TX-SR700E/600E receives characters that cannot be displayed correctly. This is not a malfunction.
- When an RDS station broadcasting PS information is selected, the name of the station is displayed instead of the frequency.

PTY program types in Europe

The text given below in parenthesis is what is actually displayed on the TX-SR700E/600E.

None (NONE):

No program type.

News reports (NEWS):

Reports on current events and happenings.

Current affairs (AFFAIRS):

Topical reporting of current affairs, often with a wider range of topics than news reports.

Information (INFO):

General information such as weather forecasts, consumer affairs, medical help, etc.

Sport (SPORT):

Live sports action, sports news, and interviews.

Education (EDUCATE):

Formal educational programs.

Drama (DRAMA):

Radio plays and serials.

Culture (CULTURE):

Cultural programs (including religious affairs).

Science and technology (SCIENCE):

Programs about the natural sciences and technology.

Varied (VARIED):

Speech-based programs not covered by the above categories (e.g., quizzes, panel games, and comedy).

Pop music (POP M):

Popular commercial music, usually from past or present sales charts (e.g., Top 40).

Rock music (ROCK M):

Popular music with an alternative appeal, often not appearing on sales charts.

Middle of the road music (M.O.R.M):

Easy listening music (as opposed to Pop, Rock, or Classical).

Light classics (LIGHT M):

Classical music for general rather than specialist appreciation.

Serious classics (CLASSICS):

Performances of major orchestral works, symphonies, chamber music, etc. (including the Grand Opera).

Other music (OTHER M):

Music styles not covered by the above categories (e.g., Jazz, Rhythm & Blues, Folk, Country, and Reggae).

• Alarm (ALARM):

When an RDS station is making an emergency broadcast, ALARM will flash on the display.

Listening to RDS broadcasts

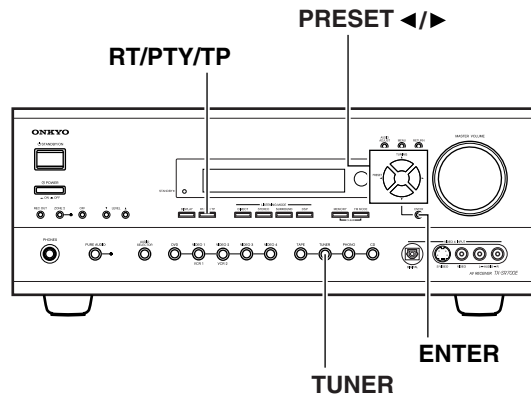

Displaying Radio Text (RT)

If the station you are currently tuned into is broadcasting RT signals, they will be displayed in the front display of the TX-SR700E/600E. If the station does not, this function will be ignored.

1. To display the radio text, press the RT/PTY/TP button once.



- If the station you are currently listening to is not an RDS station, only the frequency of the station will appear.
- If “Waiting” appears on the display, more time is required to receive the RT information. When the information is received, the characters will scroll across the front display.
- If “No Text Data” appears on the display, RT information is not available.
- The display shows the frequency for 3 seconds and returns to program service name.

Performing a PTY scan

1. Press the TUNER input source button and select the FM input source.



2. Press the RT/PTY/TP button twice.

The current program type appears on the display.



ROCK M

3. Using the PRESET buttons, select the PTY program type you desire.

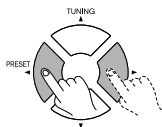

LIGHT M

4. Press the ENTER button.

The TX-SR700E/600E will scan until it reaches a station of the program type you selected. It will then stop briefly at that station before continuing on until it reaches the next station. Pressing the ENTER button stops the PTY scan at that point. If you press the RT/PTY/TP while “NONE” is displayed, “PTY ?” will appear. In this case, return to step 3.



5. Press the ENTER button when it reaches the station to which you want to listen.

“Not Found” will appear when no RDS signal is being received from the station.



Performing a TP scan

1. Press the TUNER input source button and select the FM input source.

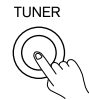

2. Press the RT/PTY/TP button three times.



[TP]

“[TP]” will appear if the current station is broadcasting TP signals. This station will periodically broadcast traffic information. To find a different station, proceed to the next step. Also, if “TP” is displayed, proceed to the next step.

3. Press the ENTER button.

The TX-SR700E/600E will scan until it reaches a station broadcasting traffic information. If “Not Found” appears on the display, a TP station cannot be located.



Selecting an Audio Component

TX-SR700/700E

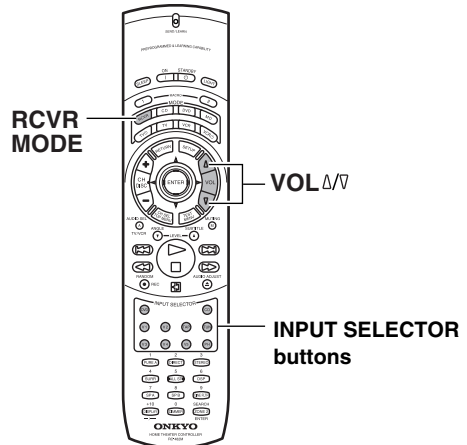
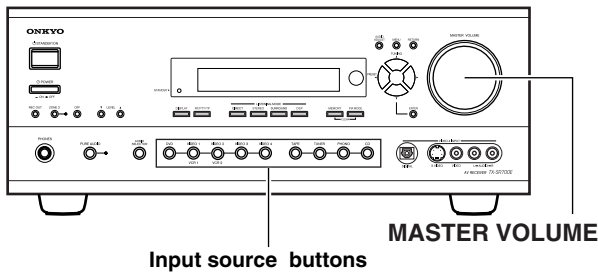

Basic operation (TX-SR700/700E)

If you want to perform these operations using the remote controller, first press the RCVR MODE button.

1. Press the desired input source.

TX-SR700/700E

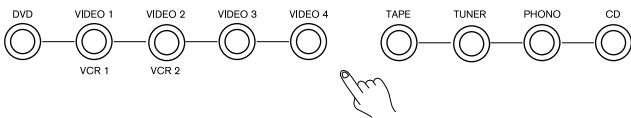

Remote controller

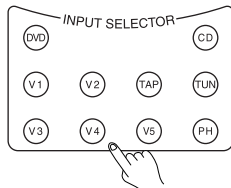

The selected source name appears on the display. See “Enjoying the multichannel output” (see page 47) when a DVD player with a 5.1-channel input port is connected to the TX-SR700/700E.

2. Start playing the selected input source.

Follow the operating instructions for the source device.

3. Adjust the volume to an appropriate level.

TX-SR700/700E

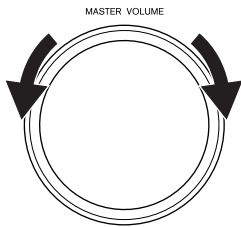

Remote controller



Adjusting the main volume adjusts the volume level of all the speakers connected to the TX-SR700/700E together. If headphones are connected, this also adjusts the volume heard from the headphone speakers. To adjust the volume, either press the VOL Δ/∇ buttons on the remote controller or turn the MASTER VOLUME dial. To increase the volume, turn the dial clockwise; to decrease the volume, turn the dial counterclockwise. The volume can be set to Min, 1 to 99, and Max.

- For more information about selecting the listening mode, see page 49.
- You can set the sound quality using the Audio Adjust menu. (See page 57 for more information.)
If no audio output is heard from the digital source (DVD, CD, etc.) you have selected, see “Digital Input” on page 53.

Selecting an Audio Component

TX-SR600/600E

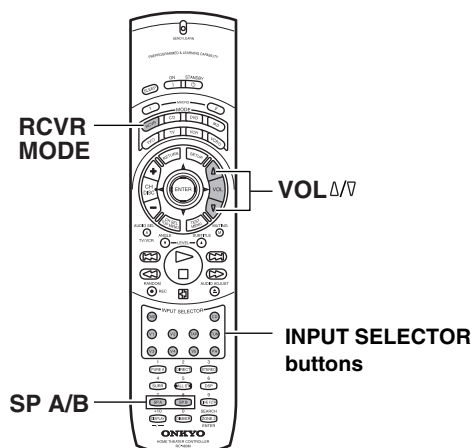
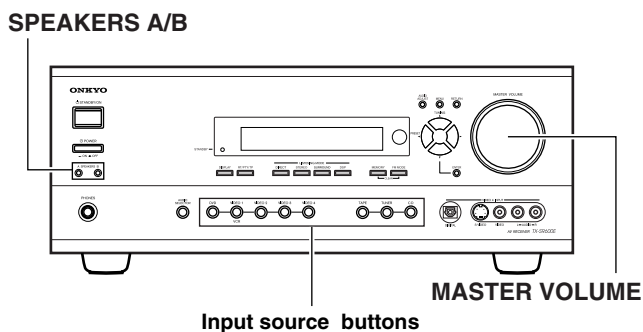

Basic operation (TX-SR600/600E)

To use the remote controller, first press the RCVR MODE button.

1. Press the desired input source button.

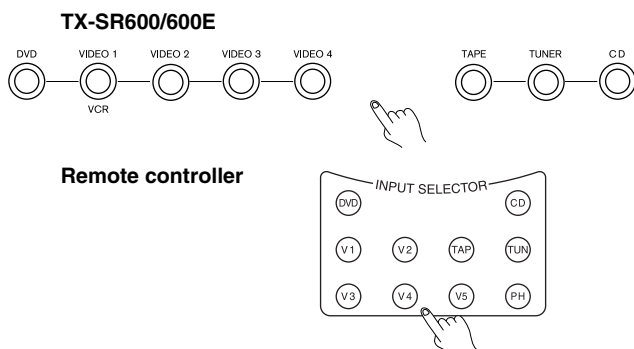

The selected source name appears on the display. See “Enjoying the multichannel output” (see page 47) when a DVD player with a 5.1-channel input port is connected to the TX-SR600/600E.

2. Make sure that the SPEAKERS A indicator (A) is lit on the display. If it is not lit, press the SPEAKERS A (SP A) button.

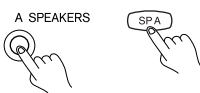

(Refer to the “Selecting speakers” section on this page for more details.)

3. Start playing the selected input source.

Follow the operating instructions for the source device.

4. Adjust the volume to an appropriate level.

These controls allow you to adjust the volume of the front A speakers, center speaker, surround speakers, surround back speaker, and subwoofer simultaneously. Turning the control clockwise increases the volume level. Turning the control counterclockwise decreases the volume. The volume can be set to Min, 1 to 99, and Max.

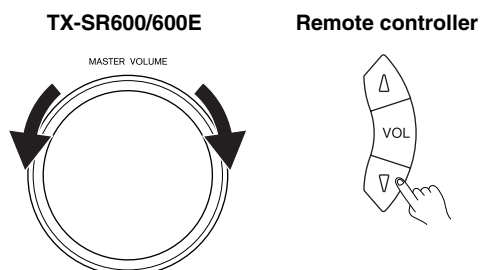

- For more information about selecting the listening mode, see page 49.
- You can set the sound quality using the Audio Adjust menu. (See page 57 for more information.)
If no audio output is heard from the digital source (DVD, CD, etc.) you have selected, see “Digital Input” on page 53.

Selecting speakers (SPEAKERS A, B) (TX-SR600/600E only)

SPEAKERS A: This button turns on or off the speakers connected to the FRONT SPEAKERS, CENTER SPEAKER, SURROUND SPEAKERS, SURROUND BACK SPEAKER, and SUBWOOFER terminals.

When you listen to surround audio or select multi channel input, be sure to turn on SPEAKERS A.

When the speakers are turned on, the SPEAKERS A indicator (A) lights up.

SPEAKERS B: This button turns on or off the speakers connected to the FRONT SPEAKERS B terminals.

When the speakers are turned on, the SPEAKERS B indicator (B) lights up.

Notes:

- You cannot select surround sound when you are using SPEAKERS B.
- When using the B speakers, the A speakers can only be used for stereo or direct playback. Audio is output from the subwoofer. However, when playing a multichannel audio source, sound is not output to the center speaker, surround speakers, surround back speaker, and subwoofer.

Selecting an Audio Component

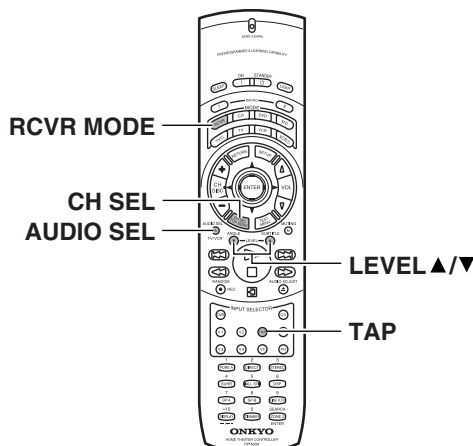
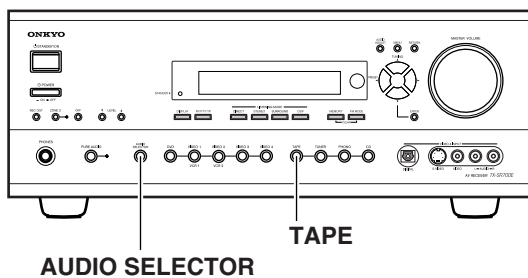

Selecting the type of audio input signal

Press the AUDIO SELECTOR button on the front panel (or AUDIO SEL button on the remote controller) to change the audio mode. Each time the button is pressed, the mode changes from “Auto” → “Multich” (only if DVD is selected as the input source) → “Analog” and back to “Auto.”

TX-SR700/700E/600/600E

Remote controller



Auto (automatic detection): With this setting, the TX-SR700/700E/600/600E automatically detects whether the input signal is digital or analog. When a digital signal is not input, then the analog signal is played. This setting only appears if a digital input is selected for the Digital Input setting at “Input Setup” → “Digital Input” (see page 53).

Multich (Multichannel): Select this setting to play back the multi-channel input from a DVD player with a 5.1-channel input port. This setting only appears if “Yes” is selected for the Multichannel setting at “Input Setup” → “Multichannel” (see page 54).

Analog: Select this setting to play back the input from a source component connected to analog audio input jacks. With this setting, even if a digital signal is input from the same component, only the analog signal will be output.

Temporarily changing the speaker output levels

To change the individual speaker volumes temporarily, follow the procedure given below. Each channel can be set between -12 and +12 decibels. Note that the calibration settings will return to the original settings when the TX-SR700/700E/600/600E is put in standby.

Using the remote controller:

1. Press the RCVR MODE button.



2. Press the CH SEL button and select the desired speaker.



3. Press the LEVEL ▲ or ▼ button to adjust the volume level.



Notes:

- You cannot select a speaker if the configuration value of the speaker is set to “No” or “None.”
- If the speaker level is set to +1 dB or higher, the maximum level indicated on the display will change if you raise the volume level.
- When you press the TEST button after you set the level, the current level will be used as the value set via the test tone.

To change the display of the input source from TAPE to MD

If you connected an MD recorder to the TAPE jacks of the TX-SR700/700E/600/600E, you can have “MD” appear when the TAPE source button is pressed. By changing the display, when an Onkyo MD recorder is **RI**-connected, the **RI** system functions will become enabled.

Changing the display:

Press and hold down the TAPE source button until the display changes from TAPE to MD (approx. 3 seconds).

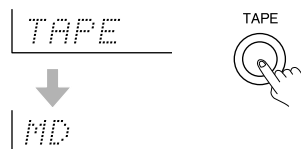

To return the display to its original setting, perform the same procedure. This setting is necessary to allow **RI** system functions for a connected Onkyo cassette tape or MD recorder.

Selecting an Audio Component

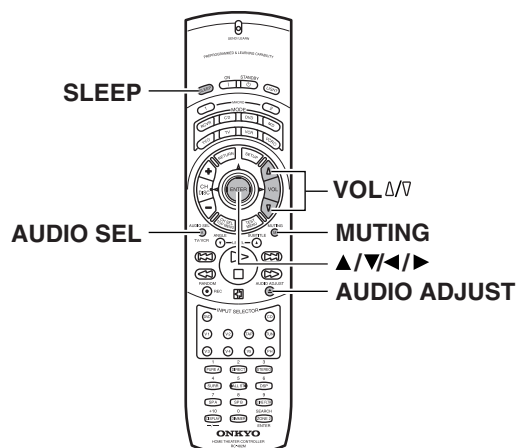
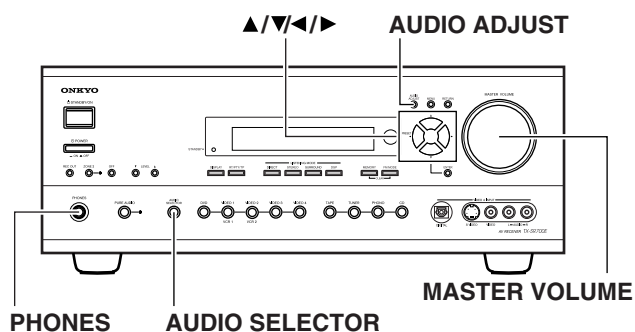

Using the sleep time (remote controller only)

The SLEEP button enables you to set the TX-SR700/700E/600/600E to turn off automatically after a specified time period. If you press it once, the TX-SR700/700E/600/600E will turn off after 90 minutes. Each time it is pressed thereafter, this remaining time until the TX-SR700/700E/600/600E turns off decreases by 10 minutes (i.e., from 90 to 80 minutes). While the sleep function is enabled, you can press the SLEEP button to see how much time is left. If the SLEEP button is pressed when the time displayed is less than 10 minutes, the sleep function is cancelled.

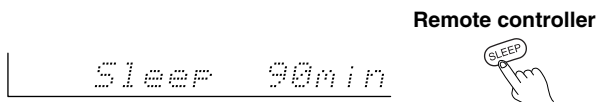

(TX-SR700/700E only)

If you are using the remote zone (Zone 2), it will turn off at the same time as the main zone. If you want to set the sleep function for Zone 2 only, set the sleep function with the main zone turned on and then put the main zone into the standby state.

Listening with headphones

To listen with headphones, plug a pair of headphones with a standard stereo plug into the PHONES jack on the TX-SR700/700E/600/600E front panel.

When you connect the headphones, the TX-SR700/700E/600/600E will enter the STEREO mode automatically and no sound will be heard from the speakers. When the headphones are unplugged, the TX-SR700/700E/600/600E returns to its original listening mode. When using the headphones, you can only use the Direct, Stereo, and Pure Audio (TX-SR700/700E only) listening modes. If you have selected multichannel audio, you will only hear the sound output to the front right and left channels.

The headphone volume level can be adjusted at the Setup Menu (see page 56).

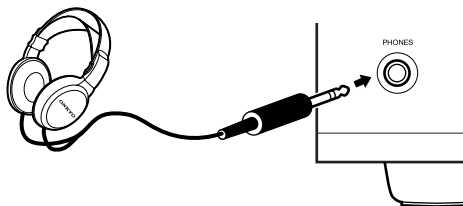

(TX-SR700/700E only)

Note:

The signal to the remote zone (Zone 2) will not be affected by whether or not headphones are connected.

Enjoying DVD multichannel audio playback

Before starting operations, first make sure that the multichannel connection is properly made and that “Yes” is selected for the Multichannel setting at “Input Setup” → “Multichannel” (see page 54).

1. Press the DVD input source button.
2. Select “Multich” using the AUDIO SELECTOR button on the front panel (or AUDIO SEL button on the remote controller).

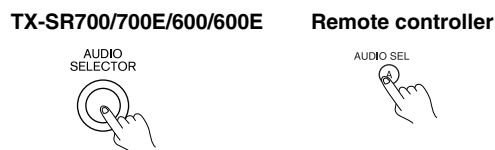

3. Turn on the connected DVD player and start playing the desired media.
4. If necessary, adjust the output level of each speaker as desired (see page 46).
Adjust the volume at each speaker so that all the volumes sound at the same level at the listening position. For the front right, front left, center, surround right, and surround left speakers, the output levels can be adjusted between -12 and +12 decibels. The subwoofer can be adjusted between -30 and +12 decibels.
5. Adjust the volume with the MASTER VOLUME dial or the VOL Δ/V buttons on the remote controller.

Selecting an Audio Component

Using the tone control:

To make bass and treble adjustment work for multichannel sources, you must first set the tone control to "On."

To turn on the tone control:

1. Press the **SURROUND** button (or **SURR** button on the remote controller).

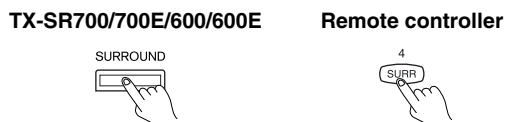

"Tone On" appears on the display and the tone control is turned on.

2. Press the **AUDIO ADJUST** button and then the **▲** and **▼** cursor buttons to select Bass (or Treble).

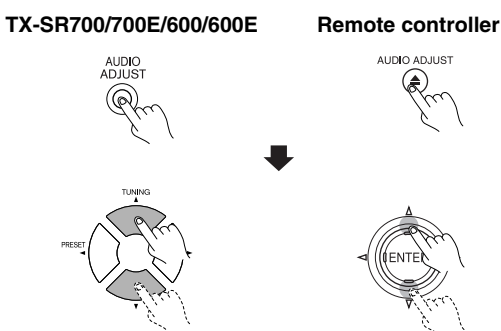

3. Press the **◀** and **▶** cursor buttons to set the desired level.

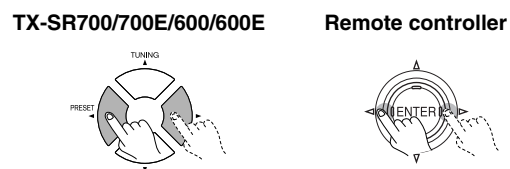

To turn off the tone control:

Press the **DIRECT** button.

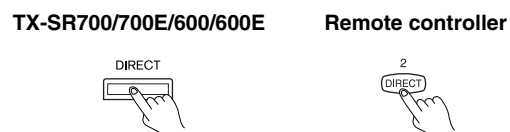

"Tone Off" appears on the display and the tone control is turned off.

Notes:

- When you play back multichannel sources, you can select the Pure Audio mode by pressing the PURE AUDIO button. To exit the Pure Audio mode, press the DIRECT or SURROUND button (TX-SR700/700E only).
- If you change the speaker levels in step 4 above, these new levels for multichannel sources will have no effect on the settings at "Level Calibration."

- Be aware that the main volume display on the front panel will differ if the speaker volume of even one speaker is changed from 0 decibels. In other words, if all the speaker levels are set to 0 decibels and you increase the main volume, the display will rise to "98," "99," and then "MAX." If you now change the level of one speaker to +5 decibels and you increase the main volume, the display will rise to "93," "94," and then "MAX."

Switching the display

While listening to or watching an input source, you can display the information regarding the type of source and signal being input by pressing the **DISPLAY** button on the TX-SR700/700E/600/600E or the remote controller.

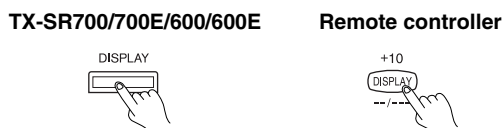

When an input source other than FM or AM is selected:

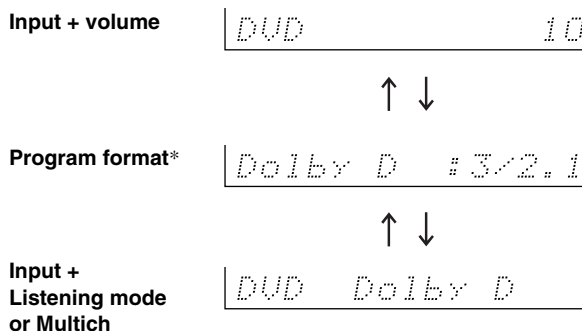

* If the input signal does not have a program format, then this will be skipped.

When FM or AM is selected as the input source:

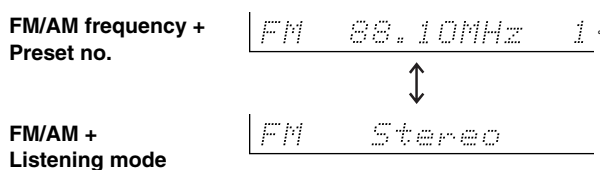

Temporarily turning off the sound

To turn off the sound momentarily, press the **MUTING** button on the remote controller. The **MUTING** indicator will flash and the sound from the speakers or headphones will be switched off by the receiver's audio muting circuit. Press the **MUTING** button again to turn the sound back on.

Remote controller



Listening Modes

The TX-SR700/700E/600/600E's surround sound enables you to enjoy the presence of a movie theater or concert hall in your room.

The configuration of the speakers is very important for the surround sound. Refer to "Connecting speakers" on page 30.

Before using a listening mode, make sure the Speaker Config, Speaker Distance, and Level Calibration parameters have been set (see pages 36 to 39). Once the parameters have been set, it is not necessary to set them again. See page 51 for information regarding how to select the listening mode.

Dolby D (Dolby Digital)

The Dolby D mode is used to play Dolby Digital sources.

Dolby Digital is digital data with AC-3 compression and a maximum of 5.1-channel* surround sound. This source signal comes from DVDs and LDs that have the  mark and therefore recorded for 5.1-channel output. This source also comes from digital satellite broadcasts that support Dolby Digital.

* 5.1-channel Digital Format

The 5.1-channel digital surround format has a variety of versions including Dolby Digital and DTS. The 5.1-channel digital surround format enables the individual recording and playing of five full-range (20 Hz to 20 kHz) channels (left and right front, center, and two surround channels) plus an LFE channel (Low Frequency Effect) for the low-range effect sound. It will create a realistic sound that can be heard in the theaters and concert halls.

Dolby Digital EX

When using surround back speakers, the Dolby Digital source is played back using the Matrix 6.1-channel decoder.

DTS

The DTS mode is used to play DTS sources.

DTS (Digital Theater System) is compressed digital data with a maximum 5.1-channel surround output (6.1-channel with DTS-ES Discrete sources) that allows for an extremely high-quality sound. This source signal requires a DVD player that supports DTS output and comes from DVDs, compact discs, and LDs that have the  mark.

DTS-ES Discrete 6.1

With the addition of the surround back channel, this new format has all 6.1 channels recorded independently for a completely discrete digital format. Since all channels are recorded independently, high-fidelity surround playback with the increased feeling of a separated sound space is achieved.

DTS-ES Matrix 6.1

This format has the surround back channel matrix encoded and inserted into the left and right surround channels so that at playback the output for the left, right, and back surround channels are decoded using a high-precision matrix decoder.

Dolby Pro Logic II

Opposed to Dolby Pro Logic, which had four channels (front, left, center, and surround) recorded into two channels with matrix processing and then played back in four channels, Dolby Pro Logic II uses a feedback logic circuit to have 5.1-channel surround audio (Dolby Surround, etc.) matrix-encoded into two channels and then played back in its original 5.1-channel form.

Dolby Pro Logic II provides a Movie mode designed for playing movies and a Music mode designed for listening to music. In the Movie mode, the surround channels, which used to provide monaural output over only a narrow frequency range, now provide complete stereo output over the full frequency range. The result is movie viewing with a realistic feel of movement. The Music mode uses the surround channels to provide a natural soundfield that cannot be provided with normal stereo output.

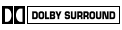
This mode can be used with VHS and DVD videos with the  mark and certain television programs. The Music mode can be used with music compact discs and other stereo sources.

DTS Neo:6

This mode is for 6.1-channel playback of sources such as PCM or analog sources that have only two channels. The outputs of all six channels are a wide frequency range with a great separation between the different channels.

This mode can be set to the Cinema mode designed for playing movies and the Music mode designed for listening to music.

The Cinema mode is good for movies. The reproduced surround sound provide the same realistic feel of movement as 6.1-channel sources. This mode can be used with VHS and television programs with stereo sound.

The Music mode uses the surround channels to provide a natural sound space that cannot be provided with normal stereo output. This mode can be used with music CDs and other stereo sources.

Direct

This mode delivers pure sound with minimum sound quality adjustment and filtration. The sound recorded for the right and left front channels is output to the right and left front speakers only and not output to the subwoofer.

Pure Audio (TX-SR700/700E only)

Same as the direct mode except that the pure audio mode also turns off the display window, turns off the power supply to the video circuitry, and minimizes the sources of noise. The result is high-fidelity music playback true to the original source.

Note that if you connect a device to the COMPONENT VIDEO INPUT 2 jacks of the TX-SR700/700E, the relay switch activates and signals are output to the COMPONENT VIDEO OUTPUT jacks. Therefore, the display on the monitor connected to the COMPONENT VIDEO OUTPUT jacks will not disappear.

Stereo

This mode has all the input sound output from the left and right front speakers. The subwoofer is also used for playback.

Listening Modes

Orchestra

This mode is appropriate for classical and opera music. The center channel is cut and the surround channels are emphasized to widen the stereo image. It will simulate the natural reverberation that is created in large halls.

Unplugged

This mode is suitable for acoustical instrumental sounds, vocals, and jazz music. By emphasizing the front stereo image, it will simulate the acoustics that you would experience in front of the stage.

Studio-Mix

This mode is for rock and popular music. The lively sounds are enhanced for a powerful acoustic image that simulates the feeling of being in a club or rock concert.

TV Logic

This mode gives realistic acoustics to TV programs that are aired from TV studios. It enhances the entire surround sound and clarity of the conversation.

All Ch Stereo

This mode is designed for playing background music. The front, surround, and surround back channels create a stereo image that encompasses the entire area.

Listening Modes

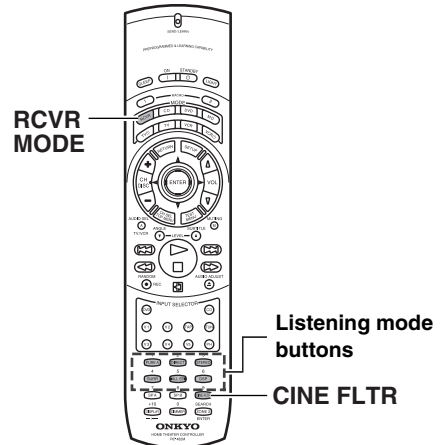
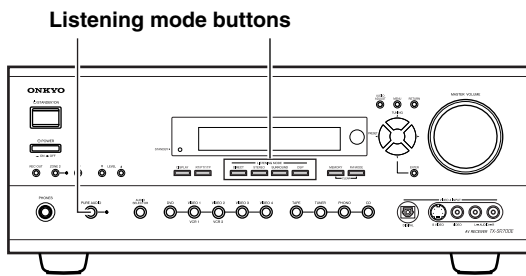

Selecting a listening mode

- Refer to page 49 for more details of listening modes.
- Refer to page 55 for sources and listening modes.
- When playing Dolby Digital or DTS software, the listening mode will automatically change to Dolby Digital or DTS.

Tip: You can set in advance a different listening mode for each input source. For more details, see page 55.

When using the remote controller, first press the RCVR MODE button before preceding to the step below.

Press one of the listening mode buttons to select the listening mode.

**TX-SR700/700E/
600/600E**

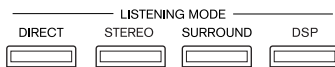

Remote controller

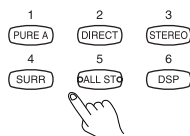

PURE AUDIO (PURE A) (TX-SR700/700E only): Changes the listening mode for the signal type that is currently being input from the selected input source to the Pure Audio listening mode. If pressed, the corresponding setting in the “Input Setup” menu for the selected input source is also changed (see page 54).

DIRECT: Changes the listening mode for the signal type that is currently being input from the selected input source to the Direct listening mode. If pressed, the corresponding setting in the “Input Setup” menu for the selected input source is also changed (see page 54).

STEREO: Changes the listening mode for the signal type that is currently being input from the selected input source to the Stereo listening mode. If pressed, the corresponding settings in the “Input Setup” menu for the selected input source is also changed (see page 54).

SURROUND (SURR): Changes the listening mode for the signal type that is currently being input from the selected input source to the surround mode that matches the signal type (e.g., Dolby Pro Logic II, Dolby Digital, DTS, or DTS Neo:6). If pressed, the corresponding settings in the “Input Setup” menu for the selected input source is also changed (see page 54).

If the SURROUND button is pressed

- **While playing back DTS sources**
Each time you press the button, the DTS-ES setting switches from: Auto → On → Off.

Auto: When a DTS source with a DTS-ES flag (ID signal for DTS-ES) is input, the listening mode changes automatically to DTS-ES Discrete 6.1 or DTS-ES Matrix 6.1. If the DTS source has no DTS-ES flag, the source is played in DTS mode.

On: When a DTS source with a DTS-ES flag is input, the listening mode changes automatically to DTS-ES Discrete 6.1 or DTS-ES Matrix 6.1. If the DTS source has no DTS-ES flag, the source is played in DTS-ES Matrix 6.1.

Off: DTS sources are always played in the DTS mode. The DTS-ES modes are not used even when the DTS source has the DTS-ES flag.

- **While playing back Dolby Digital (Multichannel) sources**
Select whether or not to play back Dolby Digital sources using the matrix 6.1-channel decoder when using surround back speakers.
Each time you press the button, the Dolby Digital EX setting switches from: Auto → On → Off.

Auto: Sources with an EX flag (ID signal for Dolby Digital) are automatically played back in Dolby Digital EX. If the source has no EX flag, the source is played back in Dolby Digital.

On: When a Dolby Digital source with an EX flag is input, the listening mode changes automatically to Dolby Digital EX. If the Dolby Digital source has no EX flag, the source is played in the Dolby Digital EX.

Off: Dolby Digital sources are always played in the Dolby Digital. The Dolby Digital modes are not used even when the Dolby Digital source has the EX flag.

Be aware that if the surround channel is monaural or there is no surround channel, the source is played back in Dolby Digital regardless of this setting.

- **While playing back Dolby Digital 2-channel sources**
Each time you press the button, the Dolby Digital setting switches from: Pro Logic II Movie → Pro Logic II Music.
- **While playing back Analog/PCM sources**
Each time you press the button, the Dolby Digital setting switches from: Pro Logic II Movie → Pro Logic II Music → DTS Neo6:Cinema → DTS Neo6:Music.
If “None” is selected for the surround speaker setting in the “Speaker Config” menu, DTS Neo:6 Music will not appear.

Listening Modes

ALL ST (remote controller only): Changes the listening mode for the signal type that is currently being input from the selected input source to the All Ch Stereo listening mode. If pressed, the corresponding setting in the “Input Setup” menu for the selected input source is also changed (see page 54).

DSP: Changes the listening mode for the signal type that is currently being input from the selected input source as shown below.

Orchestra → Unplugged → Studio-Mix → TV Logic → All Ch Stereo → Orchestra.

If pressed, the corresponding settings in the “Input Setup” menu for the selected input source is also changed (see page 54).

Original filter (CinemaFILTER) loading for movies

The CinemaFILTER function gently decreases the level of the extreme high frequencies, compensating for overly-bright sounding motion picture soundtracks. Select this function if the sound from the front speakers is too bright.

This function only works in the Dolby Digital, Dolby Digital EX, Dolby Pro Logic II Movie, DTS, DTS-ES Discrete 6.1, DTS-ES Matrix 6.1, DTS Neo:6 Cinema Surround modes.

Press the CINE FLTR button on the remote controller.

The current setting is displayed. Press the button again to change the setting.

On: The CinemaFILTER function is used during playback.

Off: The CinemaFILTER function is not used during playback.

Input Setup

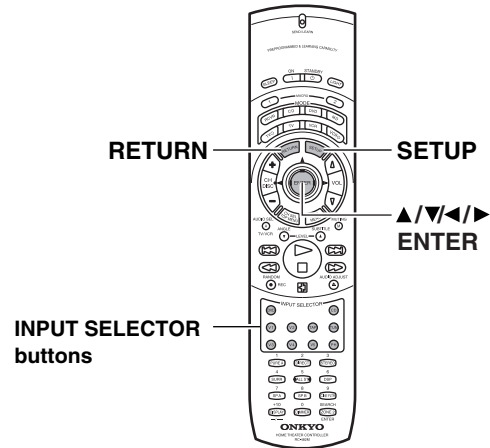
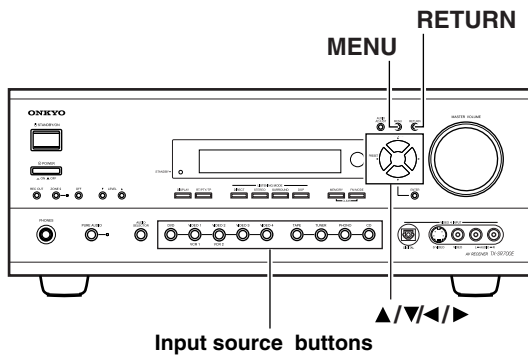

This menu allows you to make the various settings concerning the signals input from the various input sources that you use with the TX-SR700/700E/600/600E. The settings made in this menu are valid for the input source that is currently selected with the input source buttons at the front panel and, therefore, these settings are made separately for each input source.

Setup Procedure

1. Select the desired input source.

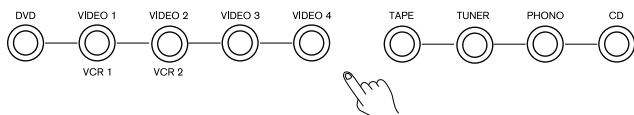

2. Press the MENU button on the front panel or SETUP button on the remote controller.

The main menu appears.

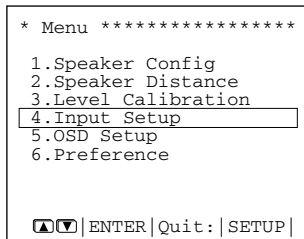

4. Input Setup

3. Use the ▲ and ▼ cursor buttons to select “4. Input Setup” and then press the ENTER button.

The “Input Setup” menu appears.

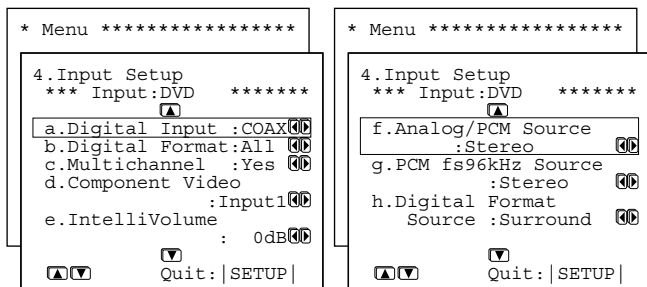

D. Input : COAX

A/PCM: Stereo

4. Use the ▲ and ▼ cursor buttons to select an item and then use the ◀ and ▶ cursor buttons to set the desired value.

Press the RETURN button to return to the main menu. Press the MENU button on the front panel or SETUP button on the remote controller to exit the Setup menu.

a. Digital Input

This setting tells the TX-SR700/700E/600/600E which input source button on the front panel is connected with which digital input jack on the rear panel.

For example, if the input source selected at the front panel is CD and the compact disc player is connected to DIGITAL INPUT OPTICAL 2, then select “OPT2” here. If the input source selected is not connected to a digital input, then select “----.”

OPT1, 2: Select if the input source is connected to either of the DIGITAL INPUT OPTICAL 1 or 2 jack.

COAX: Select if the input source is connected to the DIGITAL INPUT COAXIAL jack.

----: Select if the input source is not from a digital input jack.

The default settings are given below.

Input source	Digital input
CD	OPT 1
PHONO*	----
TAPE	----
DVD	COAX
VIDEO 1	----
VIDEO 2	----
VIDEO 3	OPT 2

---- : Available for digital input but not set in initial settings.

* TX-SR700/700E only

Notes:

- This item will not appear if the selected input source button is TUNER.
- Since VIDEO 4 is fixed to the optical digital terminal on the front panel, this item will not appear if VIDEO 4 is selected.

Input Setup

b. Digital Format

Sets the digital signal type to which priority is given during signal detection at the selected digital terminal. The default setting is “All.” If “----” is selected for this input source at the Digital Input setting, then this setting will not appear. Although you can use this default setting as is, you may change it as desired depending on the input signal format or if you know that you will always be listening to a certain input signal format from a particular input source.

All: Select for automatic detection of the input signal format. The input signal format (Dolby Digital, DTS, or PCM) used by the selected input source is detected automatically to execute the required decoding process.

DTS: Select for DTS signal processing. The decoding process is executed only when DTS signals are input.

PCM: Select for PCM signal processing. The decoding process is executed only when PCM signals are input.

Notes:

- If “All” is selected and a compact disc or LD is fast-forwarded during playback, decoded PCM signals may produce a skipping sound. In such cases, change the setting to “PCM.”
- If a DTS signal is not input when “DTS” is selected, the TX-SR700/700E/600/600E will not automatically switch to analog output even though “Auto” is selected with the AUDIO SELECTOR button.

Notes on DTS:

- If you play a DTS-formatted CD or LD when the “PCM” setting is selected on the TX-SR700/700E/600/600E, the DTS encoded signal will not be decoded and noise will be output. This noise could damage the amplifier and speakers. Therefore, be sure to select “All” or “DTS” and use the digital input jacks (OPT or COAX) to connect the DTS source.
- If you play a DTS-formatted CD or LD when “All” is selected, you may hear a noise for a short while until the DTS decoder recognizes the DTS-encoded signal and starts operating. This is not a malfunction.
- If you press the pause or skip button on the player while playing a DTS source, a short noise may be heard. This is not a malfunction. In such cases, try playing the source in the “DTS” selected.
- The DTS indicator on the TX-SR700/700E/600/600E lights while a DTS source is played. When playback finishes and the DTS signal transmission stops, the TX-SR700/700E/600/600E remains in DTS mode and the DTS indicator remains lit. This prevents noise when you operate the pause or skip button on the player. Therefore, if the source is immediately switched from DTS to PCM, the PCM signal may not be played. In this case, stop the playback of the source on the player for about three seconds and then resume playback.
- You may not be able to play some DTS source signals from certain CD players and LD players even when you connect the player to the TX-SR700/700E/600/600E digitally. This is because the digital signal has been processed (such as the output level, sampling frequency, or frequency response) and the TX-SR700/700E/600/600E cannot recognize the signal as DTS data. Therefore you may hear noise when you play a DTS source while processing the signal.
- The outputs for the VIDEO 1 OUT, VIDEO 2 OUT, and TAPE OUT output analog audio signals. Do not record from CDs or LDs that support DTS using these outputs. If you do, the DTS-encoded signal will be recorded as noise.
- If a CD or LD encoded in the DTS format is played back with “PCM” selected, only noise will be produced. Always select “All” or “DTS” when playing back DTS-encoded sources.

c. Multichannel

This setting is available when the input source is DVD.

Select “Yes” when using a DVD player with a 5.1-channel audio output port. The default setting is “Yes.”

Note:

Press the AUDIO SELECTOR button to select Multich during playback.

d. Component Video

If the video signal from a component is input to one of the component video input banks (1 or 2), then which input source and which component video input bank must be set here.

The Component Video setting is available when the input source is DVD or VIDEO 1-4.

The default settings are given below.

Input source selected	Component video input
DVD	INPUT 1
VIDEO 1	INPUT 2
VIDEO 2	INPUT 2
VIDEO 3	INPUT 2
VIDEO 4	INPUT 2

e. IntelliVolume

This setting allows you to adjust for the volume differences between your various input source components.

When switching input sources, you may find that the output level for different components or input sources connected to the TX-SR700/700E/600/600E is different even though the main volume setting is the same. Under normal circumstances, you would then have to change the volume setting each time you change the input source. This Intelli Volume setting allows you to preset a volume level for each input source separately so that when you do switch from one input source to another, the TX-SR700/700E/600/600E adjusts the volume accordingly and the volume stays the same. If the volume is quieter than that of other sources, increase it with the ► cursor button, and if it is louder than that of other sources, decrease it with the ◀ cursor button.

The Intelli Volume can be adjusted between -12 and +12 decibels.

Input Setup

f. Analog/PCM Source

This sets the listening mode for analog or PCM sources.

Analog sources consist of LP records, FM and AM broadcasts, cassette tapes, and the such. PCM (Pulse Code Modulation) is one form of digital audio signals and is recorded directly onto compact discs and DVDs without compression.

g. PCM fs96kHz Source

This sets the listening mode for Digital PCM sources recorded with a sampling rate of 96 kHz.

Note:

This setting will not appear if “----” is selected at the “Digital Input” setting.

h. Digital Format Source

This sets the listening mode for Dolby Digital or DTS sources.

Note:

This setting will not appear if “----” is selected at the “Digital Input” setting.

Relationship between input source and listening mode

Input source signal (display)	Analog/PCM (2ch)	PCM fs96kHz	Digital Format		
			Dolby Digital (Multichannel)	DTS (Multichannel)	2ch source
Type of software	Tape, CD, MD, Record, Tuner, DVD (Stereo), LD, Digital satellite (Stereo)	DVD (96k/24bit)	DVD	DVD DTS-CD	DVD Digital satellite
Listening Mode					
Direct	●	●			
Pure Audio *1	●	●			
Stereo	●	●	●	●	●
Dolby Pro Logic II	●				● *2
Dolby Digital			●		
Dolby Digital EX			●		
DTS Neo:6	●				
DTS				●	
DTS-ES Discrete				●	
DTS-ES Matrix				●	
Orchestra	●				
Unplugged	●				
Studio-Mix	●				
TV Logic	●				
All Ch Stereo	●				

*1 TX-SR700/700E only

*2 This mode is not available for DTS sources.

Note:

You may not be able to select all the listening modes shown here depending on your speaker configuration or the selected input source.

OSD Setup and Other Settings

OSD Setup

This menu allows you to customize the OSD Setup Menu to display in the manner you desire.

To display the OSD Setup menu:

1. Display the main menu.
2. Use the **▲** and **▼** cursor buttons to select “5. OSD Setup” and then press the ENTER button.

The “OSD Setup” menu appears.

TX-SR700/700E

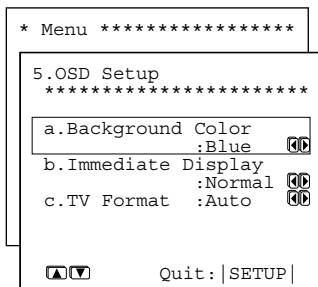

BkColor:Blue

TX-SR600/600E

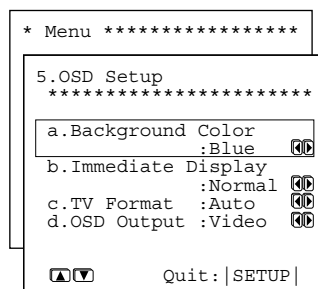

BkColor:Blue

a. Background Color

Select either Blue, Green, Magenta, or Red as the background color when the OSD Setup Menu is displayed.

b. Immediate Display

Off: Select to turn off the immediate display of operations.

Normal: Select to display operations in the bottom right corner of a TV screen with a 4:3 aspect ratio.

Wide: Select to display operations in the bottom right corner of a TV screen with a 16:9 aspect ratio.



Hint:

If this is set to “Off,” the background color will not be displayed even when there is no video signal input.

c. TV Format

(For all models other than USA and Canadian models)

The default setting is “Auto,” which means that the television format is detected and automatically set by the TX-SR700/700E/600/600E. However, if you know the correct format, you can use this setting to choose either PAL or NTSC so that no time is wasted on detection.

d. OSD Output/ c. OSD Output (TX-SR600/600E only)

Sets the OSD menu output.

VIDEO: Select this setting when the TV or projector monitor is connected to the VIDEO OUT jack.

S VIDEO: Select this setting when the TV or projector monitor is connected to the S VIDEO OUT jack.

Preference

To display the Preference menu:

1. Display the main menu.
2. Use the **▲** and **▼** cursor buttons to select “6. Preference” and then press the ENTER button.

The “Preference” menu appears.

TX-SR700/700E

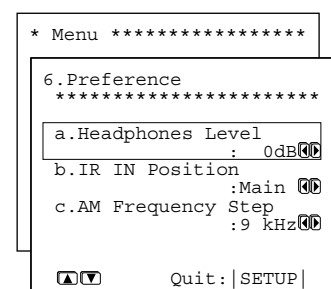

HP Level : 0.

TX-SR600/600E

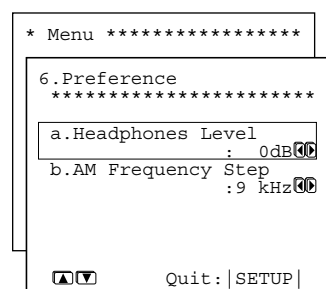

HP Level : 0.

a. Headphones Level

You can adjust the volume output from the headphones so that it matches the level output from the speakers. The headphone volume can be adjusted between -12 and +12 decibels.

b. IR IN Position (TX-SR700/700E only)

Use this setting when you have a remote control sensor connected to the IR IN terminal. The setting in this menu tells the TX-SR700/700E whether the remote control sensor is being used for operation of the TX-SR700/700E in the main zone or the remote zone (Zone 2).

Main: Select when you are using the remote control sensor for operation with the remote controller in the main zone.

Zone 2: Select when you are using the remote control sensor for operation with the remote controller in the remote zone (Zone 2).

c. AM Frequency Step (TX-SR700/700E)/ b. AM Frequency Step (TX-SR600/600E)

This setting only appears on the worldwide model. It determines the increment amount or decrement amount when adjusting the AM tuner frequency. The initial setting is 9 kHz, and this needs only to be changed if you are using the TX-SR700/700E/600/600E in a 10-kHz region.

Audio Adjust

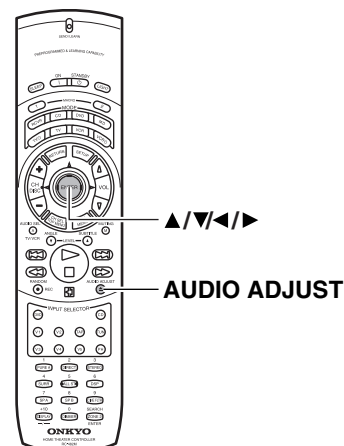
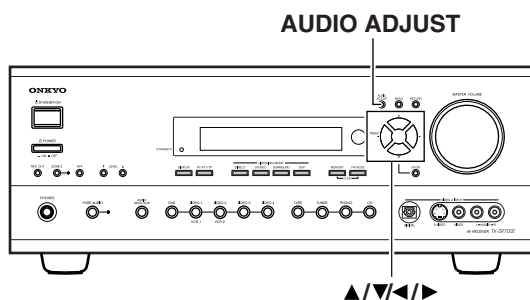

These settings are enabled depending on the listening mode or input signal.

Setup Procedure

1. Press the AUDIO ADJUST button.

The Audio Adjust settings appear in the front display and on the monitor.

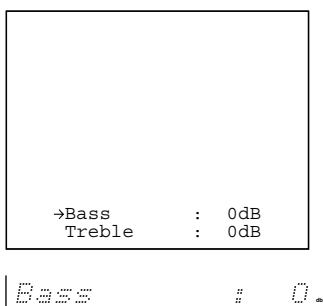

Note:

The items that appear in the menu depend on the currently selected listening mode or the input signal. (see page 59).

2. Use the ▲ and ▼ cursor buttons to select the item that you want to set.

3. Use the ◀ and ▶ cursor buttons to set the value.

Setting	Values	Initial value
Bass	-12 to +12	0
Treble	-12 to +12	0
Subwoofer (Analog/PCM)	On, Off	On
Late Night	Off, Low, High	Off
Center Image	0, 1, 2, 3, 4, 5	3
Panorama	On, Off	Off
Dimension	0, 1, 2, 3, 4, 5, 6	3
Center Width	0, 1, 2, 3, 4, 5, 6, 7	3
Front Effect*	Off, Middle, High	Middle
Surround Effect*	Off, Middle, High	Middle

* TX-SR700/700E only

Bass, Treble

Separately adjust the bass and treble settings in 2-decibel increments.

The Bass and Treble adjustments are only enabled for the front left and right speakers.

Note:

If Direct or Pure Audio is selected as the listening mode, these settings cannot be made. To make these settings, first select another listening mode.

Subwoofer

When "Yes" is selected for the "Subwoofer" setting in the "Speaker Config" menu, set this to "Off" if you do not want to have sound output from the subwoofer when listening to Analog/PCM sources. If "No" is selected for the "Subwoofer" setting in the "Speaker Config" menu, this setting will not appear.

Late Night

The audio for movies made for the cinema have a large dynamic range; thus, the difference between loud noises and soft noises is great. To hear the quieter sounds such as background noises or human conversations, the movie must be played back at larger volumes. When this setting is set to "High" or "Low," the dynamic range of the sound is narrowed down to allow you to easily hear minute sounds at low volumes. This function is especially useful if you wish to play a movie at low volumes during the nighttime.

This can be set to either "Off" or "Low," or "High." When this setting is set to "High" or "Low," the dynamic range of the sound is narrowed down to allow you to easily hear minute sounds at low volume.

Off: Select to turn off the Late Night function.

Low: Select to narrow down the dynamic range.

High: Select to further narrow down the dynamic range.

Notes:

- The Late Night function is effective only on Dolby Digital encoded software.
- The depth of the Late Night effect is determined by Dolby Digital software. With some sources, it may produce little or no effect.

Audio Adjust

Center Image

DTS Neo:6 derives a center channel from two-channel PCM and analog sources.

In cinema mode, for Lt/Rt film soundtracks, sounds steered to the center are subtracted from the left and right channels.

In music mode, the intent in the front channels is less one of steering and more one of stabilizing the front image by augmenting it with a center channel, while preserving the original perspective of the stereo mix. Therefore the derived center is never fully subtracted from the left and right channels.

Center Image is the factor controlling the amount of subtraction. It varies between 0 and 5 in steps of 1 and the default value is 3.

When Center Image=5, the factor is zero and nothing is subtracted from the left and right channels. When Center Image=0, the center channel is subtracted from the left and right channels at half level (-6 dB) for each channel. The signal level sent to the center channel output is not affected by Center Image.

This control should be set based on room layout and personal preferences. A setting of 5 allows the left and right channels to pass through unaltered from the stereo mix. A setting of 0 gives more center channel dominance, which is particularly desirable if listeners are located well off-center. At any setting, the center speaker anchors the image.

Center Image is only enabled when the listening mode is DTS Neo:6 Music.

Pro Logic II Music Panorama (Panorama)

Use this setting to extend the front stereo image to include the surround speakers for an exciting wraparound effect with side wall imaging.

On: Select to turn on the PL II Music Panorama mode.

Off: Select to turn off the PL II Music Panorama mode.

Panorama is only enabled when the listening mode is Dolby Pro Logic II Music.

Pro Logic II Music Dimension (Dimension)

Use this setting to gradually adjust the soundfield forward or backward. The setting of "3" is the normal position. Change the setting to "2" or lower to move the sound space forward setting to "4" or higher to move the sound space backward.

If the stereo recording has excessive broadness or too strong surroundness, move the sound space forward to get the appropriate sound balance. In contrast, if the stereo recording is somewhat felt like monaural or has narrowness, move the sound space backward to get more surroundness.

Dimension is only enabled when the listening mode is Dolby Pro Logic II Music.

Pro Logic II Music Center Width (Center Width)

In Pro Logic II decoding, center signals are output from the center speaker. When the center speaker is not used, the decoder will divide the center signal equally to both the front left and right speakers to create a "phantom" center sound image.

The Pro Logic II Music Center Width mode allows you to adjust from where the center sound image is heard. Using this, you can have the soundfield be heard from the center speaker only, from the front left and right speakers only (as a phantom center sound image), or from all three speakers (center, front left and right) in various level combinations. For home use, applying some width to the center signal will improve the level balance for the center and main speakers, and effect the width of the center sound image, or "weight" of the sound. Many sound recordings processed for stereo playback will be reproduced better by proper control of this setting. The recommended setting for Pro Logic II Music mode is "3." This allows you to easily distinguish the Pro Logic II Music mode from the Pro Logic II Movie mode whose setting is automatically set to "0."

Center Width is only enabled when the listening mode is Dolby Pro Logic II Music.

Front Effect (TX-SR700/700E only)

Some live recordings contain acoustic reverberation. When you play these sources, more reverberation will be applied by the DSP, creating too much reverb effects and the sound loses frame or presence. In this case, set this setting to "Off" so that no reverberation from the DSP will be applied to the sound output from the three front channels. With this setting, the sound source is played as it is without any further reverberation.

Front Effect is only enabled when the listening mode is Orchestra, Unplugged, Studio Mix, or TV Logic.

Surround Effect (TX-SR700/700E only)

You can choose from "Off," "Middle," or "High."

This adjusts the reflected and residual noises from the surround left and right speakers and surround back speaker.

Surround Effect is only enabled when the listening mode is Orchestra, Unplugged, Studio Mix, or TV Logic.

Audio Adjust

Settings possible for each listening mode

Setting	Tone Control (Bass, Treble)	Subwoofer (Analog/PCM only)	LATE NIGHT	Center Image	Panorama, Dimension, Center Width	Front Effect	Surround Effect
Listening mode							
Direct							
Pure Audio							
Stereo	●	●					
Dolby Pro Logic II	●	●	● *1		● *3		
Dolby Digital	●		●				
Dolby Digital EX	●		●				
DTS Neo:6	●	●		● *2			
DTS	●						
DTS-ES Discrete	●						
DTS-ES Matrix	●						
Orchestra	●	●				●	●
Unplugged	●	●				●	●
Studio-Mix	●	●				●	●
TV Logic	●	●				●	●
All CH Stereo	●	●					

*1 Enabled for a Dolby Digital input source.

*2 Enabled for a DTS Neo:6 Music input source.

*3 Enabled for a Dolby Pro Logic II Music source.

Enjoying music in the remote zone (TX-SR700/700E only)

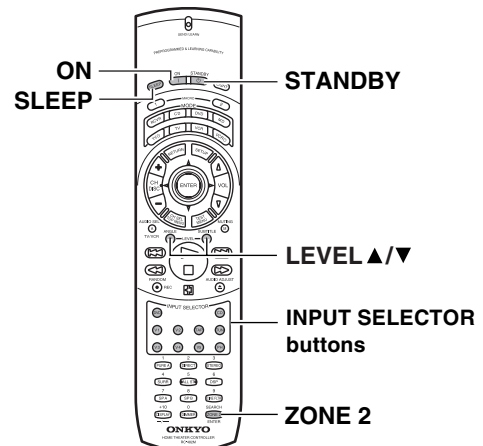
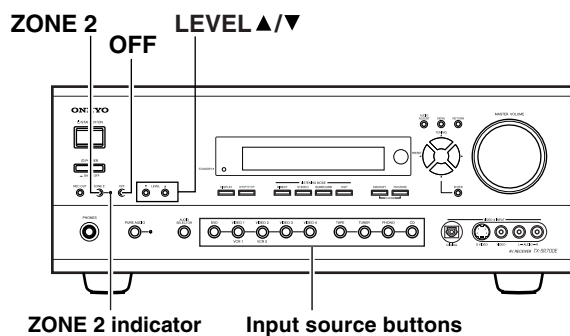

Using the buttons on the TX-SR700/700E

1. Press the **ZONE 2** button on the TX-SR700/700E.
2. **Select an input source.**
After pressing the ZONE 2 button, you must press an input source button within 5 seconds. The ZONE 2 indicator lights.

Ex.: When the CD button is pressed.

Zone2Sel:CD

To select the same source for the remote zone that is selected for the main zone, press the ZONE 2 button again until “Zone2Sel:SOURCE” appears in the display.

Zone2Sel:SOURCE

- When “Zone2Sel:Off” is displayed, the output to the remote zone is turned off.
- When you are not using the remote zone (Zone 2), press the OFF button to turn off the ZONE 2 indicator.

Notes:

- If a sleep time is set with the SLEEP button, the output to the remote zone will also turn off when the sleep time elapses.
- If the source for the main zone is selected as the source for the remote zone and the source for the main zone is changed, then the source for the remote zone will change as well.
- The ZONE 2 terminal is an analog output. Digital signals are not output. If no sound is heard from the selected input source, check if the component is connected to the analog inputs.
- If the REC OUT button is pressed in the main room while someone is using the system in the remote zone, the Zone 2 function will be deactivated and the source will turn off in the remote zone.
- If you select FM (or AM) with the TUNER input source button when the source for the remote zone (Zone 2) is set to AM (or FM), the output for the remote zone also changes to AM (or FM).
- When you are using the remote zone (Zone 2), **RI** system operation will not work.
- In the remote zone, you can only play the source in the 2-channel mode. You cannot play the source in the remote zone in the surround mode.

Using the remote controller

With the TX-SR700/700E in the standby state, turn on the output to the remote zone (**Zone 2**):

After pressing the ZONE 2 button, press the ON button within 5 seconds. The ZONE 2 indicator lights.



To turn off output to the remote zone (Zone 2), press the ZONE 2 button and then the STANDBY button within 5 seconds.

Select an input source:

After pressing the ZONE 2 button, press an input source button within 5 seconds.

If tuner is selected with the TUN button, you can use the CH +/- button to select a preset radio station.

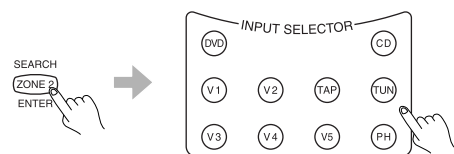

Note:

After you press the ZONE 2 button on the remote controller, the STANDBY indicator on the TX-SR700/700E flashes for five seconds. During this time, you will not be able to perform operations in the main zone using the remote controller.

Adjusting the volume for the remote zone

When the remote zone (Zone 2) speakers are connected to the ZONE 2 SPEAKERS terminals, or to an amplifier connected to the ZONE 2 PRE OUT terminals, adjust the volume as shown below.

Press the LEVEL ▲/▼ buttons on the front panel.

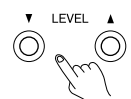

Adjusting the volume (using the remote controller):

After pressing the ZONE 2 button, the STANDBY indicator on the TX-SR700/700E will flash for 5 seconds. During this time press the LEVEL ▲/▼ button.



Recording a source (TX-SR700/700E)

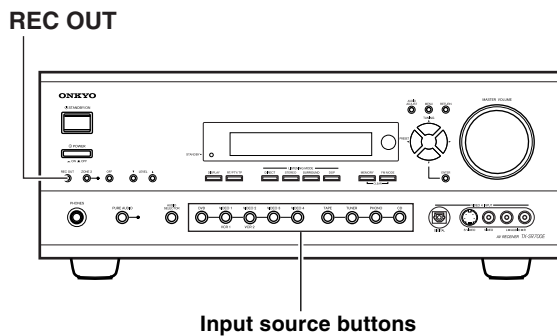

Notes:

- You cannot record the surround effects.
- Digital signals input to the DIGITAL INPUT (COAXIAL) and DIGITAL INPUT (OPTICAL) inputs will be output to the DIGITAL OUTPUT (COAXIAL) and DIGITAL OUTPUT (OPTICAL) output.
- There are some restrictions on recording digital signals. When making digital recordings, consult the instruction manual that came with your digital recording equipment (e.g., MD recorder or DAT deck) to know what restrictions are imposed.
- You cannot record the source connected to the 5.1-channel input jacks.
- If you change the input source during recording, you will record the signals from the newly selected input source.
- Digital input signals are only output to the digital outputs and analog input signals are only output to the analog outputs. There is no conversion from digital to analog or vice versa. When connecting CD players and other digital components, do not connect only the digital terminals, but the analog ones as well.

To record the input source signal you are currently watching or listening to

This method outputs to the audio and video outputs the currently selected input source signal. This method allows you to a signal while you are actually listening to or watching it.

1. **Select the input source to record by pressing the corresponding input source button.**

The input source is now selected and you may watch or listen to it as desired.

2. **Press the REC OUT button repeatedly until "Rec Sel:SOURCE" appears in the front display.**

The signal from the currently selected input source is now output to the TAPE OUT, VIDEO 1 OUT, and VIDEO 2 OUT outputs for recording.

Rec Sel :SOURCE

3. **Start recording at the recording component as desired.**

To confirm the settings, press the REC OUT button. The current settings will appear for 3 seconds in the front display.

Recording the video from one source and the audio from another:

You can add the sound from one source to the video of another source to make your own video recordings.

Below is an example of recording the sound from a compact disc player connected to CD IN and the video from a video camera connected to VIDEO 4 INPUT to a video cassette tape in a video cassette recorder connected to the VIDEO 1 OUT jack.

1. **Press the VIDEO 4 input source button.**
2. **Press the CD input source button.**
3. **Insert a CD in the CD player and insert a tape in the video camera connected to the VIDEO 4 INPUT.**
4. **Insert a video tape for recording in the video cassette recorder connected to VIDEO 1 OUT.**
5. **From this step on, follow the same procedures described in 2 and 3 above.**

To record an input source signal different from that you are currently watching or listening to

Follow the procedure given below to record an input source signal different from that which you are listening to or watching at the time of recording.

1. **Press the REC OUT button.**
2. **Within 5 seconds, press the input source selector button of the input source signal that you wish to record.**

The signal from the selected input source is now output to the TAPE OUT, VIDEO 1 OUT, and VIDEO 2 OUT outputs for recording.

Rec Sel :VIDEO3

3. **Start recording at the recording component as desired.**

To confirm the settings, press the REC OUT button. The current settings will appear for 5 seconds in the front display.

Notes:

- Be aware that the remote (Zone 2) and recording (REC OUT) outputs use the same circuit and therefore cannot be used at the same time.
- If you select FM (or AM) with the TUNER input source button when the recording source is set to AM (or FM), the output for the recording source also changes to AM (or FM).

Recording a source (TX-SR600/600E)

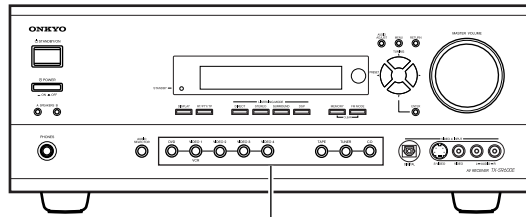

Input source buttons

Notes:

- You cannot record the surround effects.
- Digital signals input to the DIGITAL INPUT (COAXIAL) and DIGITAL INPUT (OPTICAL) inputs will be only output to the DIGITAL OUTPUT (OPTICAL) output.
- There are some restrictions on recording digital signals. When making digital recordings, consult the instruction manual that came with your digital recording equipment (e.g., MD recorder or DAT deck) to know what restrictions are imposed.
- You cannot record the source connected to the 5.1-channel input jacks.
- If you change the input source during recording, you will record the signals from the newly selected input source.
- Digital input signals are only output to the digital outputs and analog input signals are only output to the analog outputs. There is no conversion from digital to analog or vice versa. When connecting CD players and other digital components, do not connect only the digital terminals, but the analog ones as well.

To record the input source signal you are currently watching or listening to

This method outputs to the audio and video outputs the currently selected input source signal. This method allows you to a signal while you are actually listening to or watching it.

1. **Insert a media for recording into the recording component (cassette tape deck, video deck, or MD recorder).**
2. **Select the input source to record by pressing the corresponding input source button.**

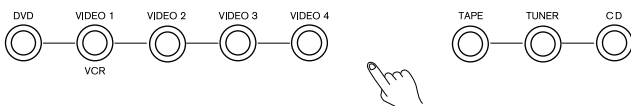

3. **Start the output source component and start recording at the recording component as desired.**

Using remote controller

* Diagram for RC-482M

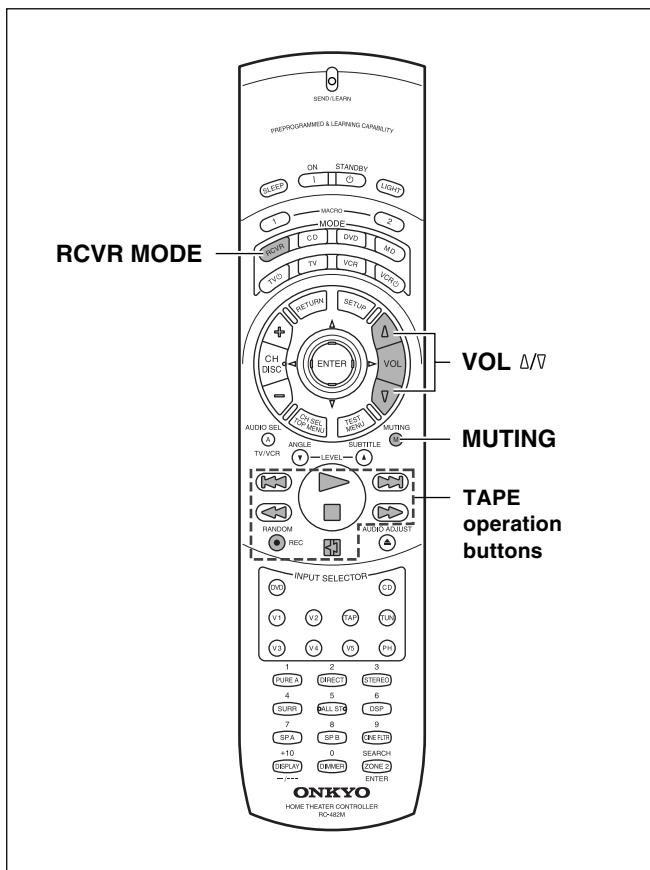
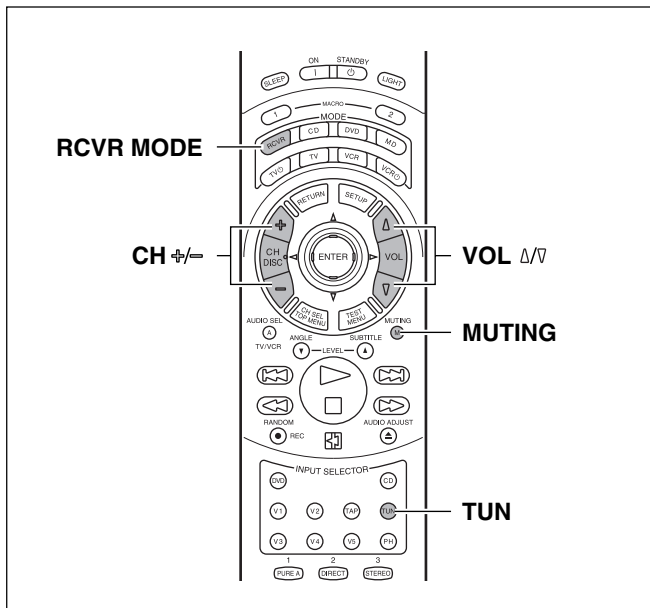

Overview

The RC-482M/480M remote controller is a useful tool that can not only operate the TX-SR700/700E/600/600E, but also all the other components of your home theater as well. To operate any component, first press the Mode button on the remote controller that corresponds to the component that you wish to control. Then simply press the desired operation button and the component will operate accordingly. For example, if you wish to select the CD input source at the TX-SR700/700E/600/600E with the remote controller, first press the RCVR MODE button to select the TX-SR700/700E/600/600E and then press the CD (INPUT SELECTOR) button.

Calling up a preset radio station

1. Press the RCVR MODE button.
The RCVR MODE button lights green.
2. Press the TUN input selector button.
3. Press the desired operation button.

Operation buttons:

CH +/-: Selects the desired preset station number

You may also use the following buttons:

VOL Δ/V: Adjusts volume at TX-SR700/700E/600/600E

MUTING: Activates muting function at TX-SR700/700E/600/600E

Controlling an Onkyo cassette tape deck

The RI connector of the Onkyo cassette tape deck must be connected to the TX-SR700/700E/600/600E (see page 29).

1. Press the RCVR MODE button.
The RCVR MODE button lights green.
2. Press the desired operation button.
The buttons shaded in the figure to the left are the operation buttons that can be used to control an Onkyo cassette tape deck.

Operation buttons:

- ▷: Play
- : Stop
- ◀: Rewind
- ▶: Fast forward
- ⏮: Skips to beginning of next track during playback
- ⏪: Skips to beginning of current track during playback
- REC: Record/Pause
- ⏮: Reverse playback

You may also use the following buttons:

VOL Δ/V: Adjusts volume at TX-SR700/700E/600/600E

MUTING: Activates muting function at TX-SR700/700E/600/600E

Note:

Even for devices with the ⏮ and ⏪ buttons, signal discrepancies may cause them not to work properly.

Using remote controller

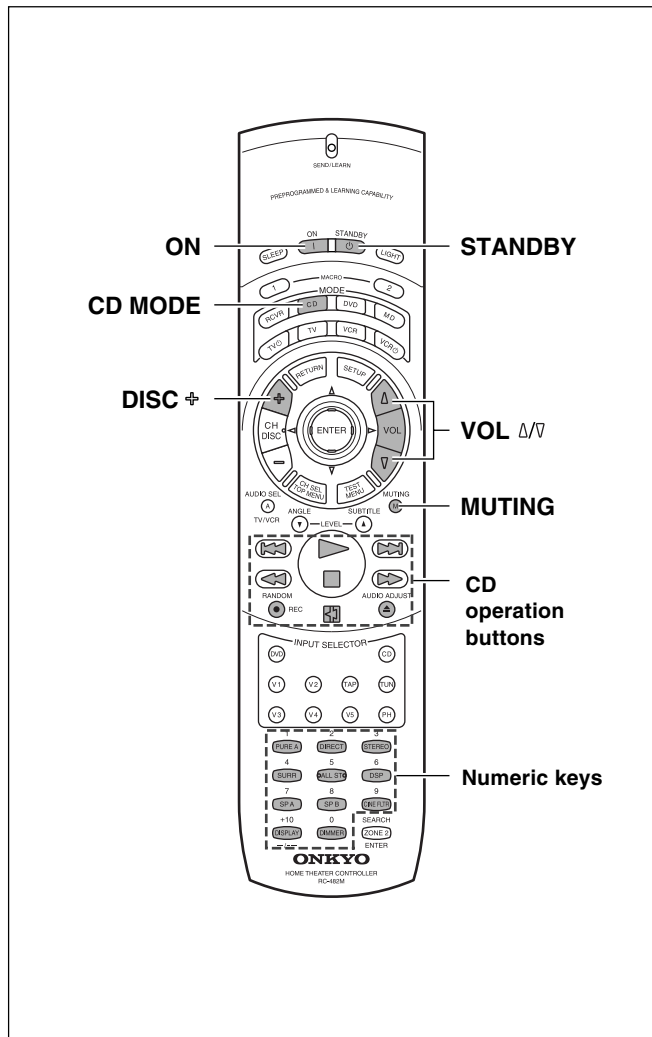

Controlling an Onkyo CD player

The **RI** connector of the Onkyo compact disc player must be connected to the TX-SR700/700E/600/600E (see page 29).

1. Press the **CD MODE** button.

The CD MODE button lights green.

2. Press the desired operation button.

The buttons shaded in the figure to the left are the operation buttons that can be used to control an Onkyo compact disc player.

Operation buttons:

ON: Turns on and off the compact disc player (same as the **STANDBY** button on the remote controller)

DISC +: Selects disc in CD changer

: Track down

: Track up

: Play

: Stop

: Skip backward

: Skip forward

: Pause

OPEN/CLOSE : Opens/closes disc tray

0, 1 to 9, +10: Numeric keys

RANDOM: Random playback

You may also use the following buttons:

VOL Δ/∇ : Adjusts volume at TX-SR700/700E/600/600E

MUTING: Activates muting function at TX-SR700/700E/600/600E

Using remote controller

Controlling an Onkyo DVD player

The **RI** connector of the Onkyo DVD player must be connected to the TX-SR700/700E/600/600E (see page 29).

1. Press the DVD MODE button.

The DVD MODE button lights green.

2. Press the desired operation button.

The buttons shaded in the figure to the left are the operation buttons that can be used to control an Onkyo DVD player.

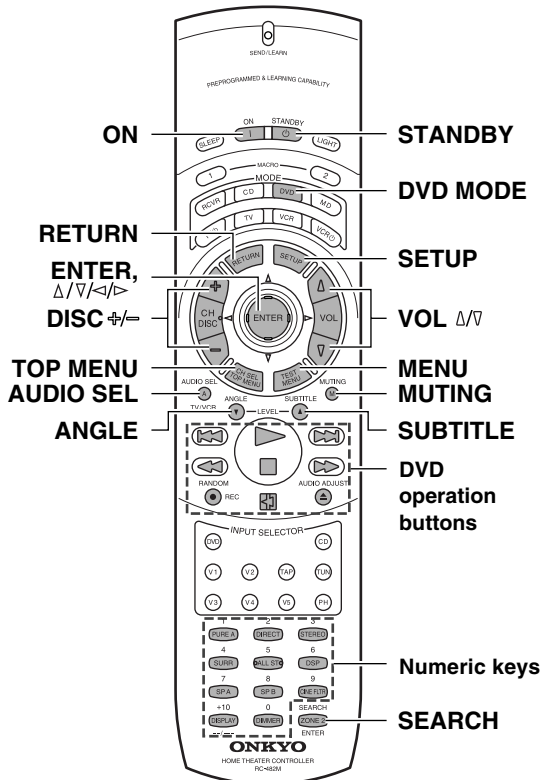

Operation buttons:

ON: Turns DVD player on and off

STANDBY: Turns DVD player off (Some sets may not respond to this button. In this case, use the ON button to put the DVD player in the standby state.)

SETUP: Displays OSD Menu of the DVD player

Δ/∇/◀/▶: Moves cursor in the OSD Menu of the DVD player

ENTER: Enter button for the OSD Menu of the DVD player

RETURN: Return button for the OSD Menu of the DVD player

TOP MENU or MENU: Displays menu screens recorded on DVD media

DISC ◀/▶: Selects disc in DVD changer

AUDIO SEL: Selects audio or language track (if recorded on the DVD)

ANGLE: Selects camera angle (if recorded on the DVD)

SUBTITLE: Selects subtitle language (if recorded on the DVD)

SEARCH: Searches for location on disc to start playback

RANDOM: Random playback

◀: Chapter/Track down

▶: Chapter/Track up

▶: Play

□: Stop

◀◀: Fast reverse

▶▶: Fast forward

⏸: Pause

OPEN/CLOSE ▲: Opens/closes disc tray

0, 1 to 9, +10: Numeric keys

You may also use the following buttons:

VOL Δ/∇: Adjusts volume at TX-SR700/700E/600/600E

MUTING: Activates muting function at TX-SR700/700E/600/600E

Note:

When operating an Onkyo DVD player directly with the remote controller without connecting the **RI** terminals, pre-programming is necessary (see page 67).

Using remote controller

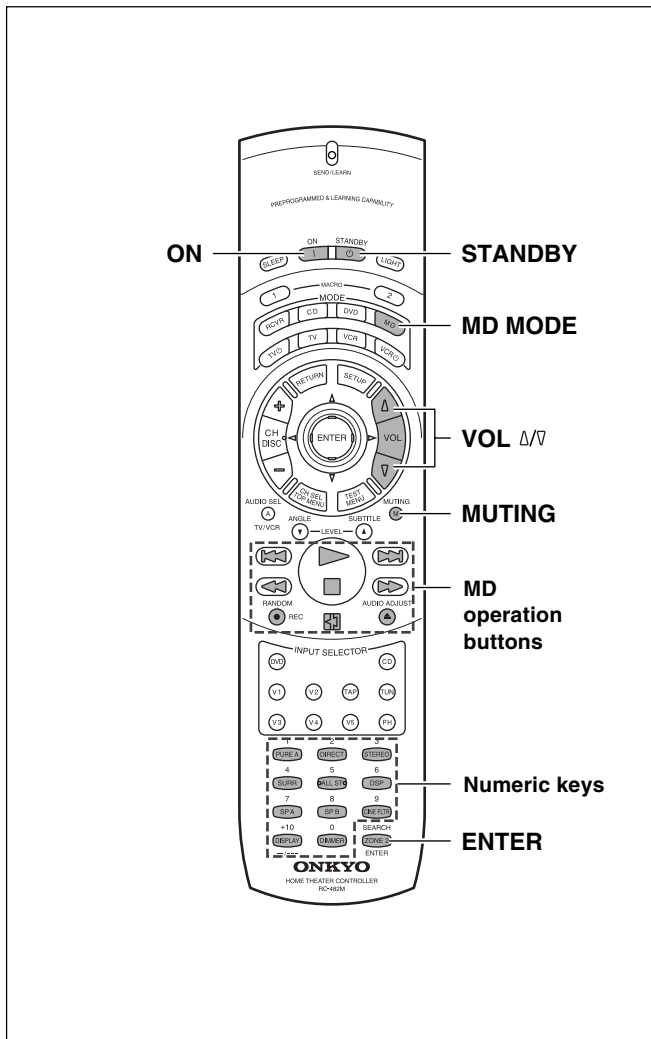

Controlling an Onkyo MD recorder

The **RI** connector of the Onkyo MD recorder must be connected to the TX-SR700/700E/600/600E (see page 29).

1. Press the MD MODE button.

The MD MODE button lights green.

2. Press the desired operation button.

The buttons shaded in the figure to the left are the operation buttons that can be used to control an Onkyo MD recorder.

Operation buttons:

ON: Turns on and off MD player (same as the **STANDBY** button on the remote controller)

: Track down

: Track up

: Play

: Stop

: Skip backward

: Skip forward

REC: Record

: Pause

: Eject

1 to 9, 0, --/--: Numeric keys

ENTER: Enters settings

You may also use the following buttons:

VOL Δ/V: Adjusts volume at TX-SR700/700E/600/600E

MUTING: Activates muting function at TX-SR700/700E/600/600E

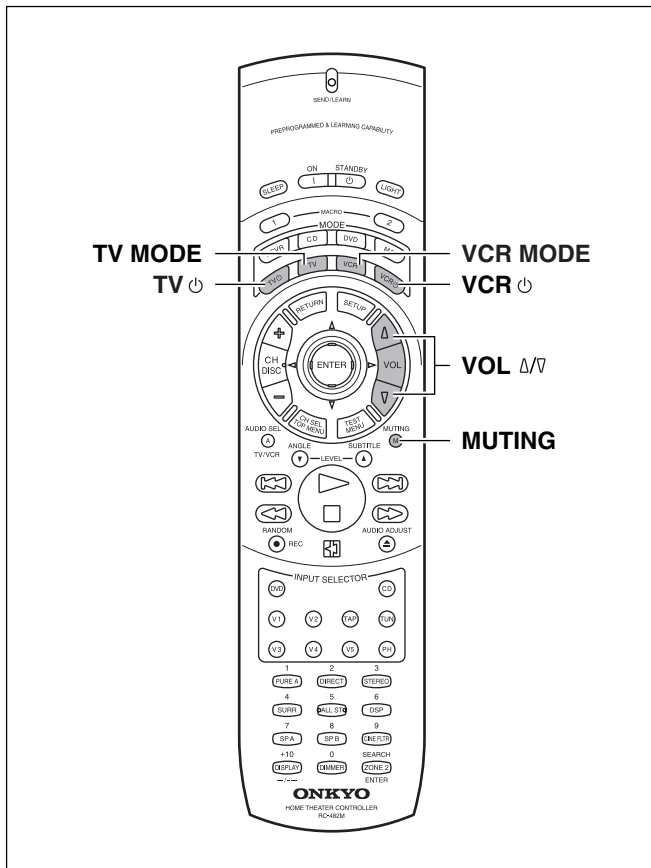

VCR and TV MODE buttons

No preset codes are programmed into the VCR and TV MODE buttons. Therefore you can use these buttons to program the remote controller signals of other devices.

There are two methods. One method is selecting the name of a different brand from the table, entering the setting number listed, and calling up the pre-programming code (see page 67). The other method is sending the commands from the other brand's remote control directly into this remote controller (see page 70).

When in the VCR and TV mode, you may use the following buttons:

VOL Δ/V: Adjusts volume at TX-SR700/700E/600/600E

MUTING: Activates muting function at TX-SR700/700E/600/600E

TV: Turns on and off the television (and switches to the TV mode)

VCR: Turns on and off the VCR (and switches to the VCR mode)

Entering a pre-programming code

The remote controller has three learning functions. One is entering the pre-programmed code for a remote controller of another manufacturer. Another is the normal learning function that enables the remote controller to learn the codes directly from other remote controllers (see page 70). And the last is a macro learning function that enables you to program a series of operations into the remote controller so that the operations can all be performed at once by pressing one button (see page 73).

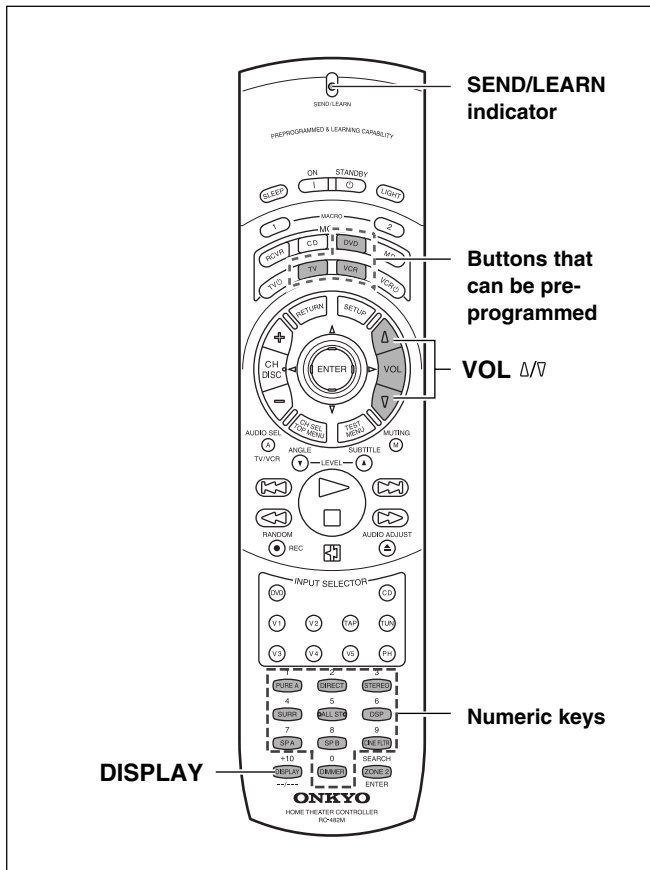

Caution: With some brand's components, some buttons may not work correctly. In this case, program the command directly from the other remote controller normally (see page 70).

Learning a pre-programming code

By entering a pre-programming code, you can have the RC-482M/480M remote controller operate a component made by another manufacturer. The buttons that are used for operation are given on the next page.

1. Find the 3-digit number listed for the manufacturer name of the component that you want to operate in the table on the next page.

2. Turn on the component that you want to operate (i.e. DVD, satellite tuner, or television).

3. While holding down the MODE button on the RC-482M/480M that you want to program, press the DISPLAY button, and then release both buttons.

The SEND/LEARN indicator lights when the MODE button is pressed and turns off when the DISPLAY button is pressed. When the indicator turns off, release both buttons. The SEND/LEARN indicator lights again.

4. Within 30 seconds, enter the 3-digit code number.

The SEND/LEARN indicator slowly flashes twice. If the SEND/LEARN indicator quickly flashes three times, then either a mistaken 3-digit code was entered or an incorrect operation was performed. If this occurs, return to step 3.

5. Press the button that you programmed and check if the system operates correctly.

- If the component does not operate properly, return to step 3 and repeat the steps above.
- If it still does not operate properly, program the command directly from the other remote controller normally (see page 70).

When entering the code of Onkyo DVD players:

There are three SETTING numbers. Choose the SETTING number according to how you will be using the DVD player.

No. 601/613: These codes are for operating the Onkyo DVD player by pointing the remote controller directly at it, either because it does not have an **RI** terminal, or it does but you are not connecting it with an **RI** cable. First enter 601 and if it does not operate properly, enter 613.

No. 600: This code is for Onkyo DVD players that have an **RI** terminal that you are connecting to the TX-SR700/700E/600/600E with an **RI** cable. You will then operate the DVD player by pointing the remote controller at the remote control sensor on the TX-SR700/700E/600/600E. You do not need to enter this code because it is factory preset. However, if the code has been changed to 601 or 613, then you will need to change it back to 600.

Entering a pre-programming code

Pre-programming codes

Note:

If more than one code is given in the table, try each code one by one until you reach a code that works (i.e. if the first code does not work, then try the next).

DVD

BRAND	SETTING No.
DENON	602, 609
HITACHI	603
JVC	604
KENWOOD	605
MAGNAVOX	606, 613
MARANTZ	607
MITSUBISHI	608, 613
ONKYO	600, 601, 613
PANASONIC	609
PIONEER	610
PROSCAN	611
RCA	611
SONY	612
TOSHIBA	613
YAMAHA	609, 614
ZENITH	613, 615

VCR

BRAND	SETTING No.
AIWA	300, 301, 302
AKAI	303, 304, 305, 306, 307
BAIRD	308
BELL & HOWELL	309
BLAUPUNKT	310
CGM	311, 312, 313
COLTINA	314
DAEWOO	315, 316
DIGITAL	317
EMERSON	318, 319, 320, 321, 322
FENNER	323
FISHER	324, 325, 326, 327
FUJITSU GENERAL	328
FUNAI	329
GE	330, 331
GO VIDEO	332, 336, 337
GOLDSTAR	333, 334
GOODMANS	335
GRUNDIG	338
HITACHI	331, 339, 340, 341, 382
JVC	342, 343, 344, 345, 346, 347, 348, 349, 350
LOEWE	351, 352
MAGNAVOX	353, 354, 355
MITSUBISHI	356, 357, 358, 359, 360, 361, 362, 363, 364
NEC	365, 366, 367
NOKIA	313
NORDMENDE	368, 369, 370
OKANO	371, 372
ORION	319, 373
PANASONIC	374, 375, 376, 377, 378
PHILIPS	353, 379, 380
PHONOLA	311
PIONEER	381

RCA	382
SABA	383
SAMSUNG	384, 385, 386, 387, 388, 389, 390
SANYO	391, 392, 393
SCOTT	394
SELECO	395
SHARP	396, 397, 398, 399
SHINTOM	400
SIEMENS	401
SONY	402, 403, 404, 405, 406, 407, 408, 409, 410, 411, 412, 413, 423
SYMPHONIC	414
TEKNIKA	414, 415
TELEFUNKEN	416, 417
TOSHIBA	418, 419, 420
WHITE	
WESTINGHOUSE	333
WATSON	421
ZENITH	422

TV

BRAND	SETTING No.
AIWA	100, 101
AKAI	102, 103, 104
AUDIOSONIC	105
BELL & HOWELL	106
BLAUPUNKT	107
BRIONVEGA	108, 109
CENTURION	110
COLTINA	111, 112, 113
CORONAD	114
CROWN	115, 116
DAEWOO	117, 118, 119, 120, 121
DUAL	122
EMERSON	123, 124, 125, 126, 127
FENNER	128, 129
FERGUSON	130, 131
FISHER	132
FUNAI	133, 134, 135
FUJITSU GENERAL	136, 137, 138
GE	139, 140, 141
GOLDSTAR	142, 143
GOODMANS	144
GRUNDIG	145, 146
HITACHI	147, 148, 149, 150
HYPHER	151
INNO HIT	152
IRRADIO	103
JVC	153, 154, 155, 156, 157
KENDO	158
KTV	159, 160
LUXOR	161
MAGNAVOX	162, 163
MARANTZ	164
MARK	165
MATSUI	166, 167, 168, 169
MITSUBISHI	170, 171, 172, 173
MIVAR	174, 175
NEC	176, 177
NOKIA	178, 179, 180, 181
OCEANIC	181
NORDMENDE	182, 183
OKANO	152
ORION	184, 185, 186
PANASONIC	187, 188, 189, 190

PHILIPS	152, 162, 191
PIONEER	192, 193
PROSCAN	194
QUASAR	195
RADIO SHACK	196
RCA	110, 141, 197, 198, 199, 200
SABA	182, 183, 201
SAMSUNG	202, 203, 204, 205, 206, 207, 208
SANYO	209, 210, 211, 212
SCHNEIDER	103
SEARS	213
SELECO	214, 215
SHARP	216, 217
SONY	218, 219, 220, 221, 222, 223
SYMPHONIC	224, 225
TELEFUNKEN	201, 226, 227
THOMSON	228
TOSHIBA	213, 229
UNIVERSUM	230
ZENITH	231, 232

Operating your programmed remote controller

After entering a pre-programming by following the procedure given above, the following modes become enabled for use.

DVD MODE (DVD Player Mode)

Operations are the same as explained on page 65.

VCR MODE (VCR Mode)

1. Press the VCR MODE button.

The VCR button lights green.

2. Press the desired operation button.

The buttons shaded in the figure to the left are the operation buttons that can be used to control your VCR.

The buttons given below have operations programmed into them.

VCR: Turns on and off the VCR

CH: Changes selected preset channel

TV/VCR: Switches VCR input setting

▷: Play

□: Stop

◀: Rewind

▶: Fast Forward

⏸: Pause

0, 1 to 9, +10: Numeric keys

You may also use the following buttons:

VOL: Adjusts volume at TX-SR700/700E/600/600E

MUTING: Activates muting function at TX-SR700/700E/600/600E

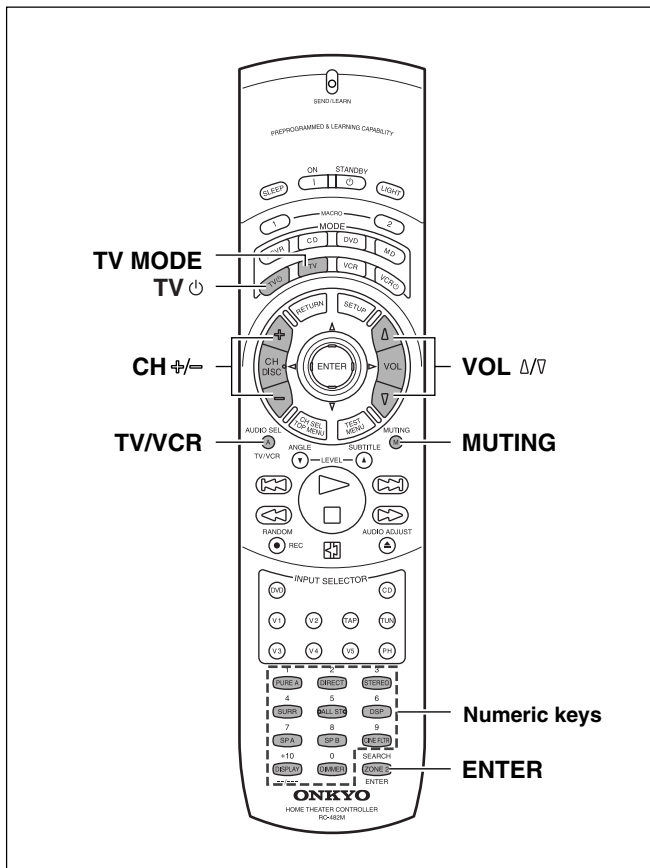
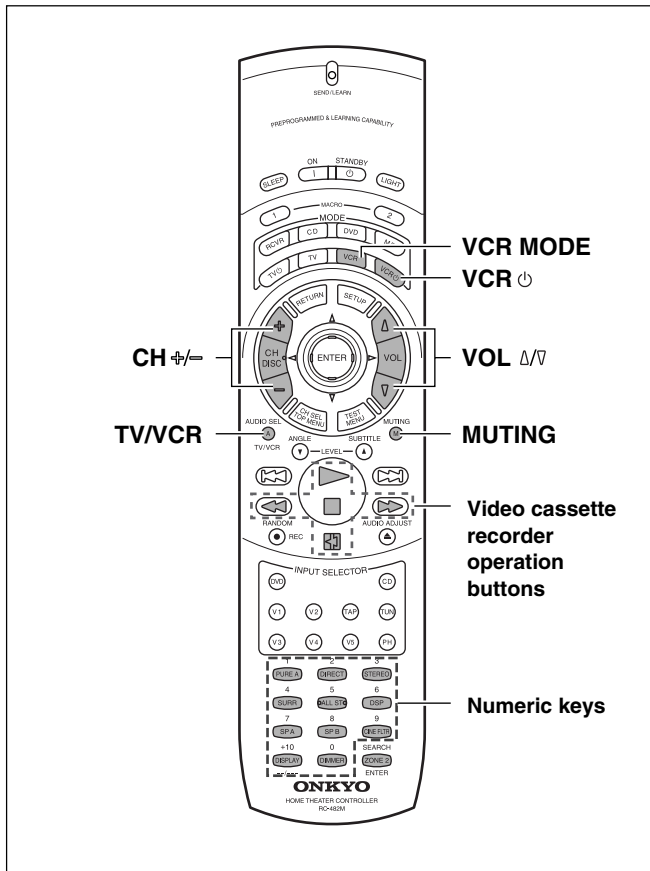

TV MODE (TV Mode)

1. Press the TV MODE button.

The TV button lights green.

2. Press the desired operation button.

The buttons shaded in the figure to the left are the operation buttons that can be used to control your television.

The buttons given below have operations programmed into them.

TV: Turns on and off the television

CH: Changes television channel

TV/VCR: Switches television input setting

0, 1 to 9, +10: Numeric keys

ENTER: Confirm

VOL: Adjusts volume at television

MUTING: Activates muting function at television

Programming the commands of remote controllers for other devices into the remote controller

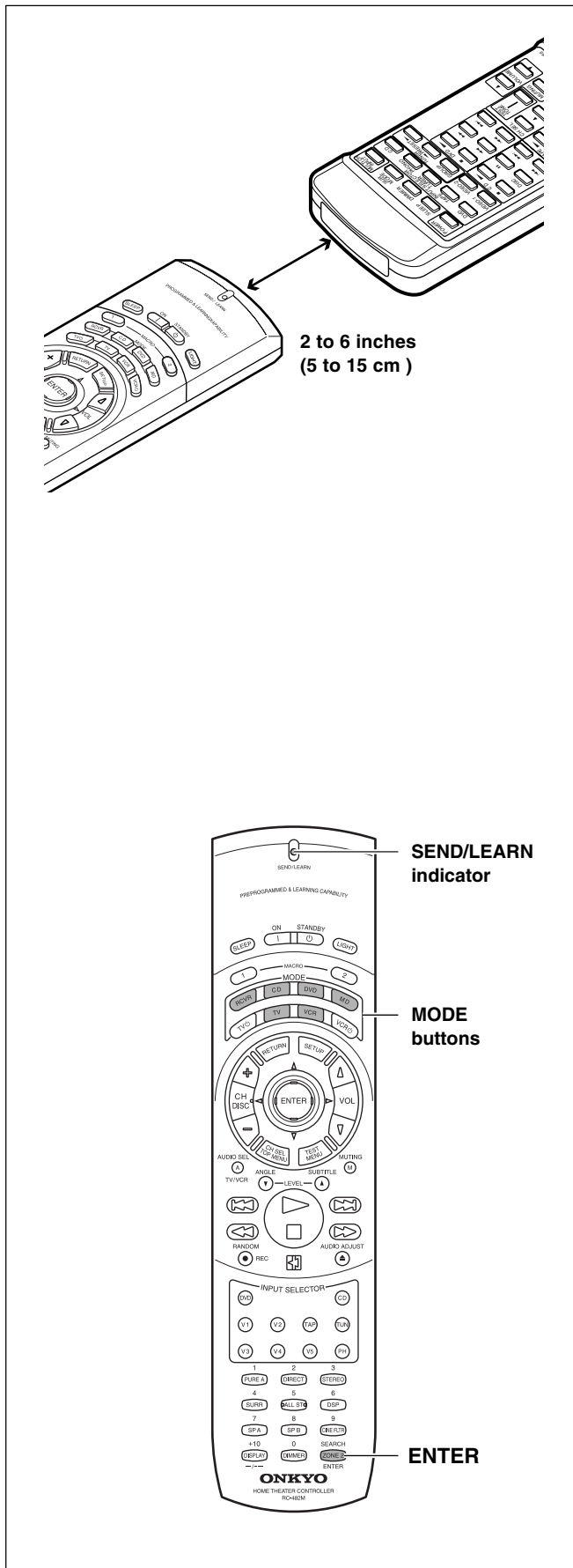

Programming procedure

When programming the commands of another remote controller to the RC-482M/480M remote controller, you must first decide under which MODE button you want the commands to be linked. In general, you will select the MODE button that corresponds to the component you are programming. For example, if you are programming the functions from a remote controller for a compact disc player, you would choose the CD MODE button. Then, by pressing the CD MODE button, the buttons on the RC-482M/480M remote controller will change to the commands you program here to operate the compact disc player.

After programming which MODE button to use, you will then transfer the separate commands from the other remote controller over to the RC-482M/480M remote controller one at a time. Each command is then programmed to a different button on the RC-482M/480M remote controller. Any button is programmable for this step except for the six MODE buttons (RCVR, CD, DVD, MD, TV, and VCR), the two MACRO buttons (MACRO 1 and 2), and the LIGHT button (RC-482M only).

Even after the commands have been memorized, keep your old remote controller in a safe place. If for some reason the commands are lost (e.g., when the batteries run down), it will be necessary to memorize them once again.

1. Place the remote controller and the remote controller for the other device facing each other at a distance of 2 to 6 inches (5 to 15 cm) apart.

2. While pressing and holding down the desired MODE button on the remote controller, press the ENTER button and then release both buttons.

The SEND/LEARN indicator lights when the MODE button is pressed and turns off when the ENTER button is pressed. When the indicator turns off, release both buttons. The SEND/LEARN indicator lights again.

3. Press and release the button on the remote controller to which you want to transfer the next command.

You may select any button excluding the eleven ones indicated in the figure below. When you press the button, the SEND/LEARN indicator turns off. When you release the button, the indicator lights again.

If you press the wrong button by mistake, press that same button again. The SEND/LEARN indicator flashes twice, and the remote controller exits the programming mode.

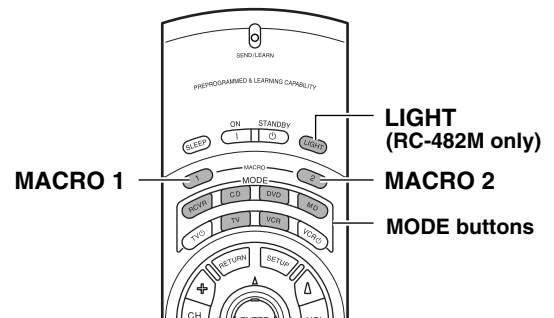

■: Buttons that cannot be programmed.

Programming the commands of remote controllers for other devices into the remote controller

- 4. Press and hold down the button (that corresponds to the command you are programming) on the remote controller of the other device until the SEND/LEARN lamp on the remote controller flashes twice.**

After flashing twice, the SEND/LEARN indicator will light again.

- 5. Repeat Steps 3 and 4 to transfer all the commands you desire from the other remote controller and program them to buttons on the remote controller under the same MODE.**

Repeat Steps 2 through 4 to program commands to a different MODE (e.g., when programming from a different remote controller).

- 6. Press the MODE button that you pressed in step 2 to complete the programming.**

- 7. Operate the newly programmed buttons to make sure the learning function was performed properly.**

Notes:

- The remote controller codes for Onkyo compact disc players, cassette tape decks, DVD players, and mini disc recorder have already been programmed into buttons on the remote controller. You may, however, use these buttons to program the codes for other remote controllers. If you wish to restore the Onkyo preset codes after you program new codes, you must first erase the new codes (see page 72).
- The remote controller has 318 memory slots (6 modes × 53 buttons). Some remote controllers may have more commands that can be remembered by the remote controller. In such cases, it will be necessary for you to determine which commands are more important than others.
- If the SEND/LEARN indicator quickly flashes three times and turns off, then the remote controller has exited the programming mode because either you have made a mistake during programming or a time-out has occurred because no button has been pressed. Resume from Step 2.
- If you try to program beyond the learning capacity of the remote controller, the SEND/LEARN indicator flashes six times quickly, and the remote controller exits the programming mode. Try programming under a different MODE button.
- When you want to program a command to a button to which you have already programmed a command, simply follow the same procedure given and the previous programming for that button will be overwritten.
- The remote controller uses infrared rays to send its commands, as do most other remote controllers. Though most remote controller codes can be memorized by the remote controller, be aware that some remote controllers use systems that are quite different from the remote controller and therefore may not be able to be programmed.
- Some remote controllers have a single button that performs multiple functions (for example, the function may change each time the button is pressed). If this is the case, each function must be programmed to a separate button on the remote controller.
- Once you have transferred the commands from the other remote controller, refer to the instruction manual that came with that product for instructions on how to operate that product.
- Make sure both the remote controller and the other remote controller have new batteries. If either of them has batteries that are low, you may not be able to program the commands of the other remote controller properly into the remote controller.

See page 72 for how to erase the memorized commands from all buttons.

Programming the commands of remote controllers for other devices into the remote controller

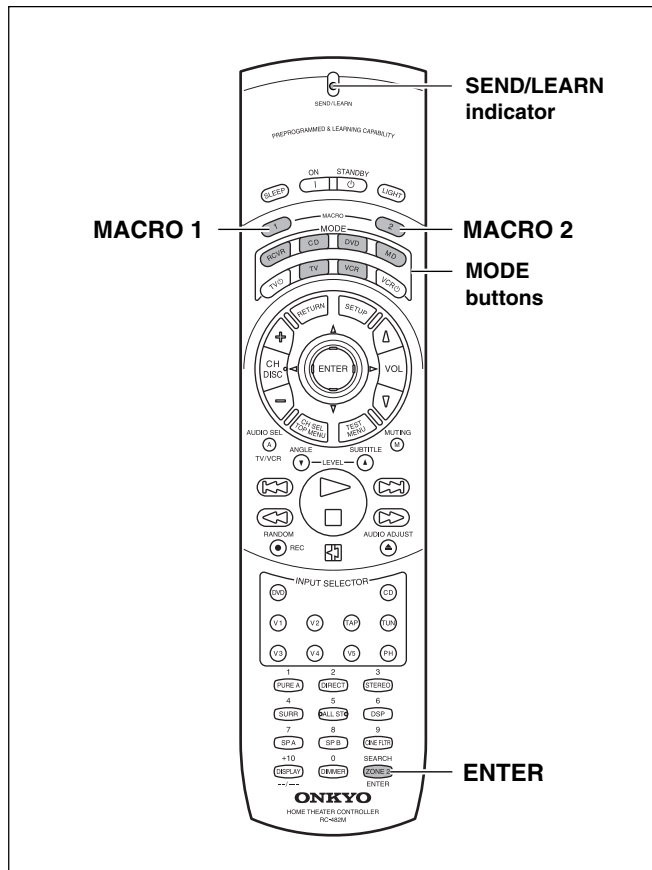

Erasing the programmed command from one button

You can only erase memorized commands and not preset ones.

1. **Press and hold down the MODE button for the command, press the ENTER button, and then release both buttons.**

When you press the MODE button, the SEND/LEARN indicator lights. When you press the ENTER button, the lamp turns off. When you release the buttons, the lamp lights again.

2. **Press and release the button for the command you wish to erase.**

When you press the button, the SEND/LEARN indicator turns off. When you release the button, the lamp lights again.

3. **Press and release the same button again.**

The SEND/LEARN lamp slowly flashes twice. The memorized command is erased.

Note:

If the SEND/LEARN indicator quickly flashes three times and turns off, then the remote controller has exited the erasing mode because either you have made a mistake during erasing or a time-out has occurred because no button has been pressed. Resume from Step 1.

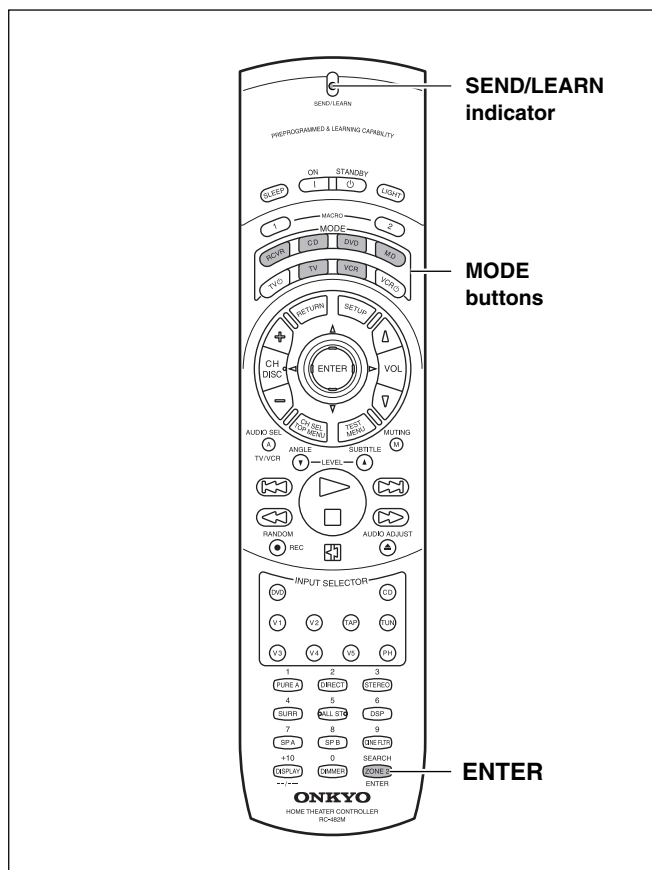

Erasing all the commands programmed under a MODE button

1. **Press and hold down the desired MODE button, press the ENTER button twice, and then release both buttons.**

When you press the MODE button, the SEND/LEARN indicator lights. When you press the ENTER button, the lamp turns off. When you release the buttons, the lamp slowly flashes twice and then lights again.

2. **Press and release the same MODE button again.**

When you release the button, the SEND/LEARN indicator slowly flashes twice. This erases all the commands memorized to the MODE button.

Notes:

- If the SEND/LEARN indicator quickly flashes three times and turns off, then the remote controller has exited the erasing mode because either you have made a mistake during erasing or a time-out has occurred because no button has been pressed. Resume from Step 1.
- If many commands have been programmed to the MODE button, then the SEND/LEARN indicator may remain lit for up to 20 seconds during Step 2. This is not a malfunction.

Using the macro function

What is the macro function?

A macro function enables you to program a series of button operations (up to 16) on the remote controller into a single button. The series of operations are then called a macro. For example, to play a compact disc player connected to the TX-SR700/700E/600/600E normally, you must perform the following steps:

1. Press the RCVR MODE button.
2. Press the ON button.
3. Press the CD (INPUT SELECTOR) button.
4. Press the CD MODE button.
5. Press the playback (▶) button.

By using the macro function, you can perform the above five operations by **only pressing one button**.

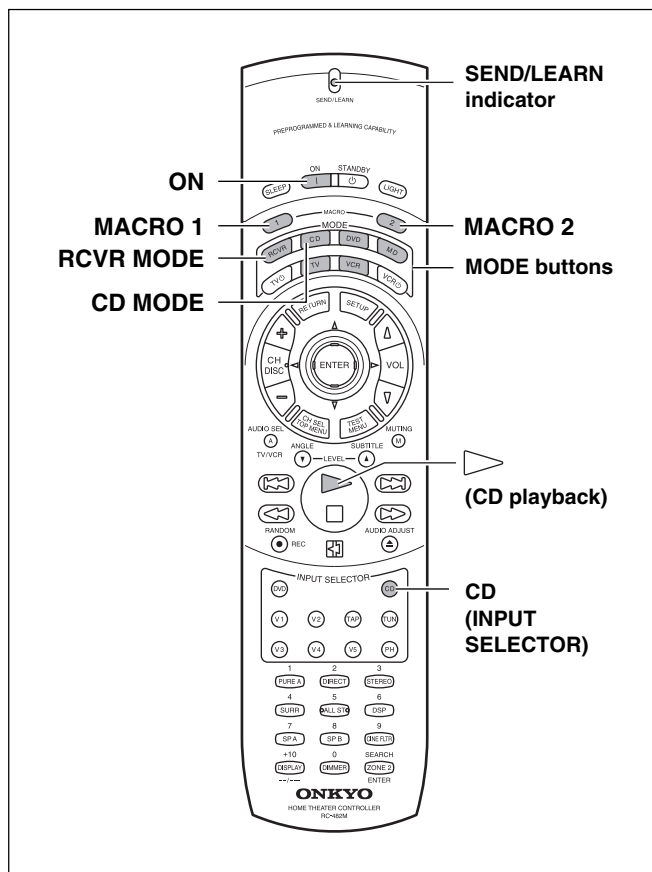

Tips:

- If you erase or change the command of a button programmed in the macro, that operation of that button will no longer work in the macro. In this case, it will be necessary for you to reprogram the macro in order to avoid incorrect operation.
- The codes programmed into the macro will be transmitted at an interval of 0.5 seconds. However, some devices may not be able to complete one operation in 0.5 seconds and may miss the next code. In this case, after pressing one operation button, you can press the same MODE button again before pressing the next operation button to add another 0.5 seconds between the two operations.

Programming the macro

With the macro function, you can program a series of button operations as a macro into the MACRO button so the macro can be executed with just one touch. Note that for the macro function, only one macro can be programmed. For example, to program the macro described above on this page for the MACRO button, perform the steps given below.

1. Press and hold down any one of the six MODE buttons, press the MACRO 1 (or 2) button, and then release both buttons.

When you press the MODE button, it lights green and the SEND/LEARN indicator lights. When you press the MACRO 1 (or 2) button, the indicator turns off. When you release the buttons, the indicator flashes briefly and then lights again.

2. Press the operation buttons you wish to program in order (in this case, press RCVR MODE → ON → CD (INPUT SELECTOR) → CD MODE → playback (▶) button).

When you press each button, the SEND/LEARN indicator turns off. When you release the button, the indicator lights.

3. Press the MACRO 1 (or 2) button to complete the procedure.

The SEND/LEARN indicator slowly flashes twice.

4. Check to see if the macro has been properly programmed.

Notes:

- You may program up to 16 button operations into the macro function. If you try to program a 17th operation, it will be ignored, and programming is stopped.
- If the SEND/LEARN indicator quickly flashes three times and turns off, then the remote controller has exited the programming mode because either you have made a mistake during programming or a time-out has occurred because no button has been pressed. Resume from Step 1.

Executing the macro

Perform the procedure below to execute the macro that you have programmed into the remote controller. After programming the macro, you should always run it at least once to make sure that it has been programmed properly.

Point the remote controller at the TX-SR700/700E/600/600E and press the MACRO 1 (or 2) button.

It may take a while for the macro to finish transmitting, so be sure to continue pointing the remote controller at the device until the SEND/LEARN indicator turns off.

Using the macro function

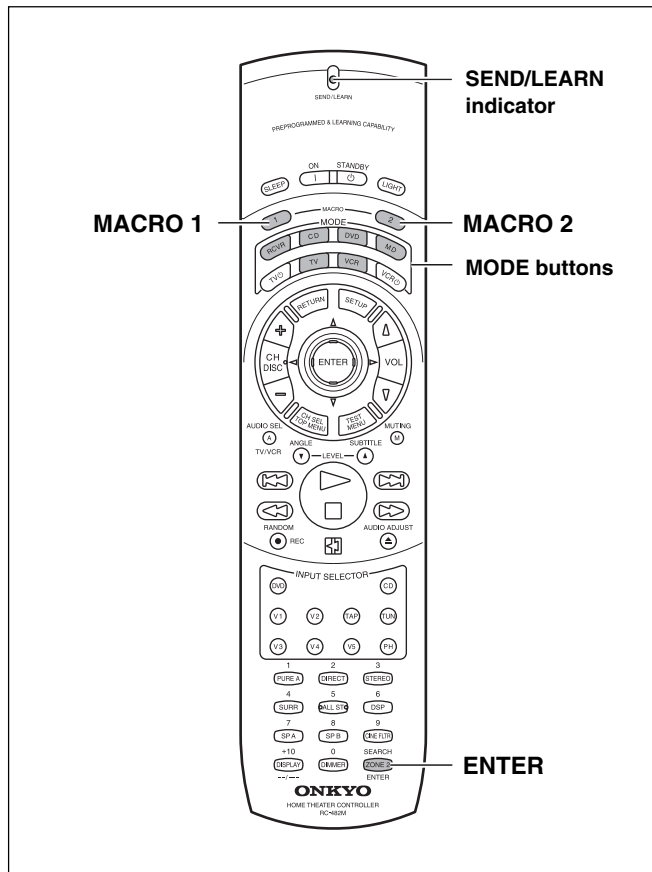

Erasing a macro from the MACRO 1 (or 2) button

1. Press and hold down any one of the six **MODE** buttons, press the **MACRO 1 (or 2)** button, and then release both buttons.

When you press the **MODE** button, it lights green and the **SEND/LEARN** indicator lights. When you press the **MACRO 1 (or 2)** button, the indicator turns off. When you release the buttons, the indicator flashes once.

2. Press the **MACRO 1 (or 2)** button again.

The **SEND/LEARN** indicator slowly flashes twice. The macro programmed to the **MACRO** button is erased.

Notes:

- If the **SEND/LEARN** indicator quickly flashes three times and turns off, then the remote controller has exited the erasing mode because either you have made a mistake during erasing or a time-out has occurred because no button has been pressed. Resume from Step 1.
- If you press a button other than **MACRO 1 (or 2)** button in Step 2, then you will in effect be overwriting the previous macro with a new macro.

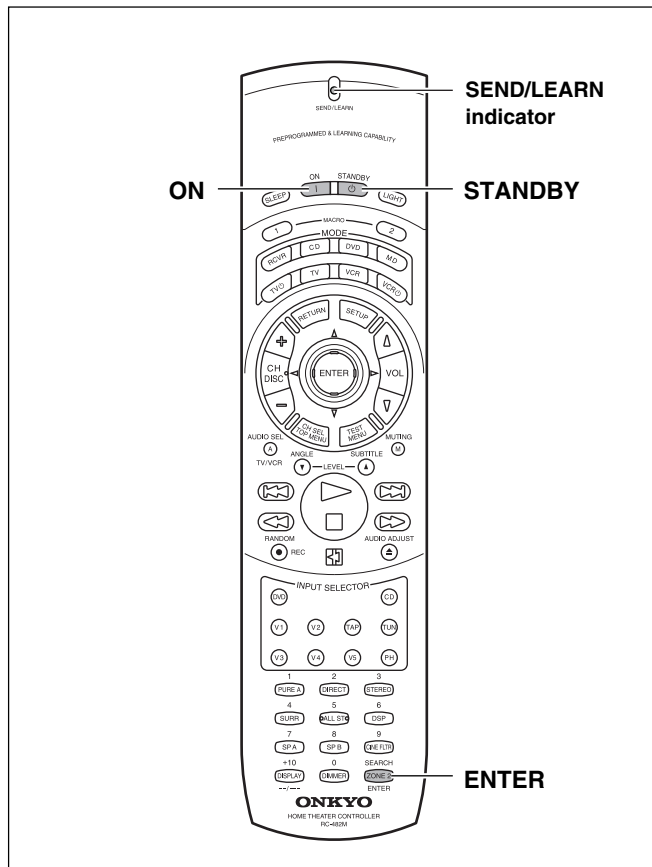

Erasing all commands and macros that have been programmed

This procedure will erase all the commands and macros that you have programmed into the remote controller and return it to its default settings. This operation will not affect the preset settings of the remote controller.

1. Open the battery cover and remove the batteries from the remote controller.

2. While pressing and holding down the **ON** and **STANDBY** buttons, re-insert the batteries in their correct orientation, and then release both buttons.

The **SEND/LEARN** indicator flashes slowly.

3. Press the **ENTER** button.

The **SEND/LEARN** indicator lights up for about ten seconds and then turns off.

All programmed commands and macros are erased and the remote controller returns to its factory presets.

Notes:

- Proceed to Step 3 immediately after Step 2; otherwise, the batteries will be consumed quickly.
- If you press any button other than the **ENTER** button in Step 3, nothing will be erased. In this case, resume from Step 1.

Using the macro function

Macro mode programming memo:

MACRO	MACRO 1	MACRO 2
Operation 1		
Operation 2		
Operation 3		
Operation 4		
Operation 5		
Operation 6		
Operation 7		
Operation 8		
Operation 9		
Operation 10		
Operation 11		
Operation 12		
Operation 13		
Operation 14		
Operation 15		
Operation 16		

Troubleshooting guide

If a problem occurs while you are using the remote controller, first try to operate the controls on the front panel of the TX-SR700/700E/600/600E to make sure that it is not due to a malfunction (or worn out batteries) in the remote controller.

POWER

No power.

- Power cord is disconnected.
→ Connect the power cord (see page 33).
- External noise is affecting the internal microcomputer.
→ Turn off the power, wait five seconds, and then turn back on the power (see page 33).
- Internal fuse is blown.
→ Contact your Onkyo Service Center.

Power turns on but no sound.

- “Muting” is displayed.
→ Press the MUTING button on the remote controller to turn off muting (see page 48).
- Bad connections or wiring.
→ Check connections, speaker cables, and other wiring (see pages 16 to 32).
- Amplifier protection circuitry is activated.
→ Contact your Onkyo Service Center.

Sound of playback source is not heard.

- Input selector is not set properly.
→ Set to correct input source.
- Headphones are connected.
→ Lower volume and then disconnect headphones.

Power shuts off immediately after power on.

- Amplifier protection circuitry is activated.
→ Remove the power cord from the outlet immediately. Contact your Onkyo service center.

SPEAKERS

No sound from the center speaker, or at very low volume.

- Speaker cable is not connected.
→ Check the connection between amplifier and speaker (see page 31).
- Listening mode is set to Stereo or Direct.
→ Set the Listening mode to any mode other than Stereo or Direct. The output to the center speaker may differ depending on the listening mode.
- Center speaker volume is set to minimum.
→ Set the center speaker level to the appropriate volume (see page 38).
- The Center setting is set to “None.”
→ Set the Center setting to “Large” or “Small” at “Speaker Config” (see page 36).

No sound or very low volume from subwoofer.

- Subwoofer setting is set to “No.”
→ Set the Subwoofer setting to “Yes” at “Speaker Config” (see page 36).
- Subwoofer volume is set to minimum.
→ Set the subwoofer level to the appropriate volume (see page 38).

Low frequency humming is heard.

- Turntable motor is not properly grounded. (TX-SR700/700E only)
→ Check for proper ground connection.
- Audio connection cables on the rear panel are connected incorrectly.
→ Adjust the placement of the cable to reduce hum.

Howling is heard when the volume is turned up. (TX-SR700/700E only)

- Turntable and speakers are located too close together.
→ Move them farther apart.

Rough or scratchy sound is heard. High range is not clear.

- Turntable needle is dirty or worn (TX-SR700/700E only), or a problem exists with a connected component.
→ Refer to the instruction of the connected components and check for problem.
- Treble control is too high.
→ Turn treble setting down at Audio Adjust → Treble (see page 57).

FM/AM TUNER

AM stations cannot be received.

- AM loop antenna is not connected.
→ Connect the included AM loop antenna to the AM antenna terminals (see page 34).

Buzzing noise on AM stations (particularly noticeable at night or with weak stations).

- Noise from electrical apparatus such as fluorescent lamp.
→ Move the AM loop antenna to different position.
→ Set up an outdoor AM antenna (see page 34).

Noise is heard at high-pitched sounds on AM stations.

- Noise caused by TV set.
→ Place the AM loop antenna as far as possible from the TV.
→ Move TX-SR700/700E/600/600E away from TV set.

Crackling noise on both AM and FM stations.

- Noise caused by fluorescent lamp being turned on and off.
→ Move antenna as far as possible from the fluorescent lamp.
- Noise from automobile ignition.
→ Install an FM outdoor antenna as far as possible from the road (see page 35).
→ Change the position or direction of the outdoor antenna.

Troubleshooting guide

Stereo indicator lights, but sound is distorted and stereo separation is bad.

- Station is too strong.
→ Change to FM indoor antenna (see page 34).
- Multiple reflection of the radio waves because of tall buildings or mountains.
→ Use antenna that has better directivity and orient it so distortion is least.

Indicators for stereo reception flicker and hiss is heard on FM stations.

- Station is too weak.
→ Install an outdoor FM antenna (see page 35).
- Stereo FM broadcasts cover only about half the distance of an ordinary broadcast.
→ Change the position or direction of the outdoor antenna (see page 35).

No preset station is recalled.

- Memory is lost because power has been turned off for a long time.
→ Store all stations again (see page 41).

VIDEO and AUDIO

Desired picture does not appear.

- Improper connection.
→ Check connections. Insert the plugs and connectors completely (see pages 14 to 29).

No OSD Menu display.

- Improper connection.
→ Check connections (see pages 14 to 29).
- OSD Menu is displayed when monitor is connected to VIDEO or S VIDEO of MONITOR OUT.
→ Check connections (see pages 20, 28).

Audio and video do not match.

- Improper connection.
→ Check connections (see page 14 to 29).

Audio is not heard or audio from different source is heard.

- Digital Input settings are incorrect.
→ Check settings at “Input Setup” → “Digital Input” (see page 53).

No picture appears on the TV screen (or monitor).

- TV (or monitor) is not set to receive the output signals from the receiver.
→ Set the TV (or monitor) to the receiver input.
- Video cable is not connected securely.
→ Check connections (see pages 14 to 29).
- Input source is connected to the COMPONENT VIDEO IN connectors.
→ Make sure TV (or monitor) is connected to COMPONENT VIDEO OUT connectors (see pages 20, 28).

REMOTE CONTROLLER

Front panel controls function but remote controller controls do not.

- No batteries in remote controller.
→ Insert batteries (see page 7).
- Batteries have worn out.
→ Replace batteries (see page 7).
- Remote controller is not pointed at the remote sensor of the TX-SR700/700E/600/600E.
→ Point the remote controller at the remote sensor of the TX-SR700/700E/600/600E (see page 7).
- Remote controller is too far from the TX-SR700/700E/600/600E.
→ Operate the remote controller within 16 feet (5 meters) (see page 7).
- Remote controller is functioning in a different mode
→ Press the RCVR MODE button.

OTHER

LATE NIGHT function cannot be used.

- Playback source is not Dolby Digital encoded.
→ Check that the DOLBY DIGITAL indicator lights up on the display.

Desired parameter cannot be set.

- Parameter may not be able to be set due to current listening mode.
→ Check settings in Audio Adjust (see pages 57 to 59).

Multichannel audio is not output.

- The Multichannel setting is set to “No.”
→ Set the Multichannel setting to “Yes” at “Input Setup” → “Multichannel” (see page 54).
- DVD player is not connected to 5.1-channel input jacks.
→ Check connections (see pages 18, 25).

Components in remote zone (Zone 2) do not operate properly. (TX-SR700/700E only)

- Components are incorrectly connected.
→ Check connections.
- Objects are interfering with remote controller signals.
→ Move interfering objects away from path of remote controller signals.

Sound is sometimes heard and sometimes not heard with digital sources.

- One digital input format has been specified so other digital formats are not played.
→ Select “All” at “Input Setup” → “Digital Format” (see page 54).

Noise during playback or skipping of the beginning sounds occurs with DTS sources, PCM sources, and other digital sources.

- When “All” is set for the digital format setting, time is required to change formats when different sources are played.
→ Try specifying the format you are playing at “Input Setup” → “Digital Format” (see page 54).

Troubleshooting guide

If one of the messages shown below appears

“Not available with headphones use”

Operation not allowed because headphones are plugged into the TX-SR700/700E/600/600E.

“Not available with Multichannel use”

Operation not allowed while the multi-channel output is being used.

“Not available in this Sp Config”

Will not work with the current speaker configuration settings.

“Not available in Zone 2 mode” (TX-SR700/700E only)

Setting not allowed because the Zone 2 mode is turned on.

“Only available with Dolby D”

No setting other than Dolby Digital can be set.

“Not available in this Listening mode”

Will not work with the current listening mode.

“Not available with this signal”

The listening mode cannot be selected with the current input source.

“Not available with Muting”

Operation not allowed because the muting is activated.

“Zone 2 is not On” (TX-SR700/700E only)

Will not work because the Zone 2 has not been turned on.

Also refer to the respective instruction manuals of the CD player, DVD player, video cassette recorder, TV monitor, etc., that compose your entertainment system.

The TX-SR700/700E/600/600E contains an internal microcomputer that performs high-level operations. However, on extremely rare occasions, noise or interference from an external source or static electricity may cause faulty operation. If this occurs, unplug the power cord from the wall outlet, wait five or more seconds, and then plug it back in. This should correct the situation.

- * To reset the surround mode and other settings to the factory default settings, hold down the VIDEO 1 button with the TX-SR700/700E/600/600E turned on and then press the STANDBY/ON button. “CLEAR” appears in the front display and the TX-SR700/700E/600/600E enters the standby state.

Specifications (TX-SR700/700E)

AMPLIFIER SECTION

Continuous average power output (FTC)

All channels: **100 W per channel min. RMS at 8 Ω, 2 channels driven from 20 Hz to 20 kHz with no more than 0.08% total harmonic distortion.**
125 W min. RMS at 6 Ω, 2 channels driven from 1 kHz with no more than 0.1% total harmonic distortion.

Continuous power output (DIN) 130 W at 6 Ω

Maximum power output (EIAJ) 160 W at 6 Ω

Dynamic power output (stereo) 2 × 250 W at 3 Ω

2 × 210 W at 4 Ω

2 × 130 W at 8 Ω

Total harmonic distortion: 0.08% at rated power

0.08% at 1 W output

IM distortion: 0.08% at rated power

0.08% at 1 W output

Damping factor: 60 at 8 Ω

Input sensitivity and impedance

PHONO: 2.5 mV, 47 kΩ

LINE (CD, TAPE, DVD,

VIDEO 1-4): 200 mV, 47 kΩ

MULTICHANNEL INPUT

(FRONT L/C/R, SURROUND

L/R): 200 mV, 47 kΩ

(SUBWOOFER): 36 mV, 47 kΩ

COAXIAL (DIGITAL): 0.5 Vp-p, 75 Ω

DVD, VIDEO 1, 2, 3, 4:

1 Vp-p, 75 Ω

1 Vp-p, 75 Ω (Y)

0.28 Vp-p, 75 Ω (C)

COMPONENT VIDEO 1, 2:

1 Vp-p, 75 Ω (Y)

0.7 Vp-p, 75 Ω (PB, PR)

Output level and impedance

Rec out (TAPE, VIDEO 1, 2): 200 mV, 470 Ω

Pre out: 1 V, 470 Ω

VIDEO (VIDEO 1, 2,

MONITOR OUT): 1 Vp-p, 75 Ω

1 Vp-p, 75 Ω (Y)

0.28 p-p, 75 Ω (C)

COMPONENT VIDEO OUT:

0.7 Vp-p, 75 Ω (PB, PR)

Phono overload: 70 mV RMS at 1 kHz, 0.5% T.H.D.

Frequency response: 10 Hz to 100 kHz : +1/-3 dB

(CD in Direct mode)

RIAA deviation: 20 Hz to 20 kHz : ±0.8 dB

Tone control

Bass: ±12 dB at 50 Hz

Treble: ±12 dB at 20,000 Hz

Signal-to-noise ratio (stereo)

Phono: 80 dB (IHF A, 5 mV input)

CD/Tape: 100 dB (IHF A, 0.5 V input)

Muting: -50 dB

TUNER SECTION

FM

Tuning range: 87.5–108.0 MHz (50-kHz steps)

Usable sensitivity

Mono: 11.2 dBf, 1.0 μV (75 Ω IHF)

0.9 μV (75 Ω DIN)

Stereo: 17.2 dBf, 2.0 μV (75 Ω IHF)

23 μV (75 Ω DIN)

50 dB quieting sensitivity

Mono: 17.2 dBf, 2.0 μV (75 Ω)

Stereo: 37.2 dBf, 20 μV (75 Ω)

Capture ratio: 2.0 dB

Image rejection ratio

USA & Canadian models: 40 dB

Other area models: 85 dB

IF rejection ratio: 90 dB

Signal-to-noise ratio

Mono: 76 dB

Stereo: 70 dB

Alternate channel attenuation: 55 dB

Selectivity: 50 dB (DIN)

AM suppression ratio: 50 dB

Total harmonic distortion

Mono: 0.2%

Stereo: 0.3%

Frequency response: 30 Hz–15 kHz, ±1.0 dB

Stereo separation: 45 dB at 1 kHz

30 dB at 100 Hz–10 kHz

AM

Tuning range

USA & Canadian models: 530 to 1,710 kHz (10-kHz steps)

European & Australian models: 522 to 1,611 kHz (9-kHz steps)

Worldwide models: 531 to 1,602 kHz (9-kHz steps)

530 to 1,710 kHz (10-kHz steps)

Usable sensitivity: 30 μV

Image rejection ratio: 40 dB

IF rejection ratio: 40 dB

Signal-to-noise ratio: 40 dB

Total harmonic distortion: 0.7%

GENERAL

Power supply

USA & Canadian models: AC 120 V, 60 Hz

European & Australian models: AC 230–240 V, 50 Hz

Some Asian models: AC 220–230 V, 50/60 Hz

Worldwide models: AC 220–230 and 120 V switchable,

50/60 Hz

Power consumption

USA & Canadian models: 6.7 A

Other models: 550 W

Dimensions (W × H × D):

435 × 175 × 431.5 mm

17-1/8" × 6-7/8" × 16-15/16"

Weight

USA & Canadian models: 27.8 lbs.

Other models: 13.1 kg

REMOTE CONTROLLER

Transmitter: Infrared

Signal range: Approx. 16 ft., 5 meters

Power supply: Two "AA" batteries (1.5 V × 2)

Specifications and features are subject to change without notice.

Specifications (TX-SR600/600E)

AMPLIFIER SECTION

Continuous average power output (FTC)	
All channels:	80 W per channel min. RMS at 8 Ω, 2 channels driven from 20 Hz to 20 kHz with no more than 0.08% total harmonic distortion. 105 W min. RMS at 6 Ω, 2 channels driven from 1 kHz with no more than 0.1% total harmonic distortion.
Continuous power output (DIN)	115 W at 6 Ω
Maximum power output (EIAJ)	145 W at 6 Ω
Dynamic power output (stereo)	2 × 215 W at 3 Ω 2 × 160 W at 4 Ω 2 × 95 W at 8 Ω
Total harmonic distortion:	0.08% at rated power 0.08% at 1 W output
IM distortion:	0.08% at rated power 0.08% at 1 W output
Damping factor:	60 at 8 Ω
Input sensitivity and impedance	
LINE (CD, TAPE, DVD, VIDEO 1-4):	200 mV, 47 kΩ
MULTICHANNEL INPUT (FRONT L/C/R, SURROUND L/R):	200 mV, 47 kΩ
(SUBWOOFER):	36 mV, 47 kΩ
COAXIAL (DIGITAL):	0.5 Vp-p, 75 Ω
DVD, VIDEO 1, 2, 3, 4:	1 Vp-p, 75 Ω 1 Vp-p, 75 Ω (Y) 0.28 Vp-p, 75 Ω (C)
COMPONENT VIDEO 1, 2:	1 Vp-p, 75 Ω (Y) 0.7 Vp-p, 75 Ω (PB, PR)
Output level and impedance	
Rec out (TAPE, VIDEO 1):	200 mV, 470 Ω
Pre out:	1 V, 470 Ω
VIDEO (VIDEO 1, MONITOR OUT):	1 Vp-p, 75 Ω 1 Vp-p, 75 Ω (Y) 0.28 p-p, 75 Ω (C)
COMPONENT VIDEO OUT:	1 Vp-p, 75 Ω (Y) 0.7 Vp-p, 75 Ω (PB, PR)
Frequency response:	10 Hz to 100 kHz : +1/-3 dB (CD in Direct mode)
Tone control	
Bass:	±12 dB at 50 Hz
Treble:	±12 dB at 20,000 Hz
Signal-to-noise ratio (stereo)	
CD/Tape:	100 dB (IHF A, 0.5 V input)
Muting:	-50 dB

TUNER SECTION

FM	
Tuning range:	87.5-108.0 MHz (50-kHz steps)
Usable sensitivity	
Mono:	11.2 dBf, 1.0 μV (75 Ω IHF) 0.9 μV (75 Ω DIN)
Stereo:	17.2 dBf, 2.0 μV (75 Ω IHF) 23 μV (75 Ω DIN)

50 dB quieting sensitivity	
Mono:	17.2 dBf, 2.0 μV (75 Ω)
Stereo:	37.2 dBf, 20 μV (75 Ω)
Capture ratio:	2.0 dB
Image rejection ratio	
USA & Canadian models:	40 dB
Other area models:	85 dB
IF rejection ratio:	90 dB
Signal-to-noise ratio	
Mono:	76 dB
Stereo:	70 dB
Alternate channel attenuation:	55 dB
Selectivity:	50 dB (DIN)
AM suppression ratio:	50 dB
Total harmonic distortion	
Mono:	0.2%
Stereo:	0.3%
Frequency response:	30 Hz-15 kHz, ±1.0 dB
Stereo separation:	45 dB at 1 kHz 30 dB at 100 Hz-10 kHz

AM

Tuning range	
USA & Canadian models:	530 to 1,710 kHz (10-kHz steps)
European & Australian models:	522 to 1,611 kHz (9-kHz steps)
Worldwide models:	531 to 1,602 kHz (9-kHz steps) 530 to 1,710 kHz (10-kHz steps)
Usable sensitivity:	30 μV
Image rejection ratio:	40 dB
IF rejection ratio:	40 dB
Signal-to-noise ratio:	40 dB
Total harmonic distortion:	0.7%

GENERAL

Power supply	
USA & Canadian models:	AC 120 V, 60 Hz
European & Australian models:	AC 230-240 V, 50 Hz
Some Asian models:	AC 220-230 V, 50/60 Hz
Worldwide models:	AC 220-230 and 120 V switchable, 50/60 Hz
Power consumption	
USA & Canadian models:	5.5 A
Other models:	450 W
Dimensions (W × H × D):	435 × 175 × 431.5 mm 17-1/8" × 6-7/8" × 16-15/16"
Weight	
USA & Canadian models:	24.5 lbs.
Other models:	12.1 kg
REMOTE CONTROLLER	
Transmitter:	Infrared
Signal range:	Approx. 16 ft., 5 meters
Power supply:	Two "AA" batteries (1.5 V × 2)

Specifications and features are subject to change without notice.

ONKYO CORPORATION

Sales & Product Planning Div. : 2-1, Nisshin-cho, Neyagawa-shi, OSAKA 572-8540, JAPAN
Tel: 072-831-8111 Fax: 072-833-5222

ONKYO U.S.A. CORPORATION

18 Park Way, Upper Saddle River, N.J. 07458, U.S.A.
Tel: 201-785-2600 Fax: 201-785-2650 <http://www.onkyousa.com>

ONKYO EUROPE ELECTRONICS GmbH

Industriestrasse 20, 82110 Germering, GERMANY
Tel: 089-849-320 Fax: 089-849-3265 E-mail: info@onkyo.de

ONKYO CHINA LIMITED

Units 2102-2107, Metroplaza Tower I, 223 Hing Fong Road, Kwai Chung, N.T., HONG KONG Tel: 852-2429-3118 Fax: 852-2428-9039

